



Total-Lift Bed™

Elevating Patient Care & Mobility

ASSEMBLY, OPERATING AND MAINTENANCE MANUAL

Bed Model:

VG-TLB 425T

➤ Total -Drive

DEALER: This manual MUST be given to the user of the product.

USER: BEFORE using this product, read this manual and save for future reference.

For more information regarding VitalGo products, parts, and services, please visit www.vitalgosys.com



WARNING

DO NOT OPERATE THIS EQUIPMENT WITHOUT FIRST READING AND UNDERSTANDING THIS MANUAL. IF YOU ARE UNABLE TO UNDERSTAND THE WARNINGS, CAUTIONS, AND INSTRUCTIONS, CONTACT A HEALTHCARE PROFESSIONAL, DEALER OR TECHNICAL PERSONNEL BEFORE ATTEMPTING TO USE THIS EQUIPMENT - FAILURE TO DO SO COULD RESULT IN DAMAGE, INJURY AND DEATH OF THE USER/ PATIENT.

THE INITIAL SET UP OF THIS BED MUST BE PERFORMED BY A QUALIFIED TECHNICIAN.

PROCEDURES OTHER THAN THOSE DESCRIBED IN THIS MANUAL MUST BE PERFORMED BY A QUALIFIED TECHNICIAN.

FOR DEALERS ONLY - SET-UP AND ASSEMBLY INSTRUCTIONS ARE INCLUDED IN THIS MANUAL. THESE PROCEDURES MUST BE PERFORMED BY A QUALIFIED TECHNICIAN ONLY.

PLEASE NOTE: Updated versions of this manual are available on www.vitalgosys.com.

SPECIAL NOTES

Signal words are used in this manual and apply to hazards or unsafe practices which could result in personal injury or property damage. Refer to the text below for definitions of the signal words.

SIGNAL WORD DEFINITIONS:

DANGER - Danger indicates an imminently hazardous situation which, if not avoided, could result in death or serious injury.

WARNING - Warning indicates a potentially hazardous situation which, if not avoided, could result in death or serious injury.

CAUTION - Caution indicates a potentially hazardous situation which, if not avoided, could result in property damage.

NOTICE

THE INFORMATION CONTAINED IN THIS DOCUMENT IS SUBJECT TO CHANGE WITHOUT NOTICE.

Vitalgo products are specifically designed and manufactured for use in conjunction with Vitalgo accessories. Accessories designed by other manufacturers have not been tested by Vitalgo and are not recommended for use with Vitalgo products.

DANGER/ WARNING/ CAUTION SUMMARY

- **KEEP HANDS AND FEET CLEAR OF ALL MOVING PARTS.**
- **DO NOT ALLOW SMALL CHILDREN ON OR NEAR BED DURING OPERATION.**
- **DO NOT ALLOW THIS DEVICE TO BE OPERATED BY SMALL CHILDREN.**
- **WHEN OPERATING THE HI-LOW, KNEE, TILTING, LEG REST OR BACK FUNCTION OF THE BED, ALWAYS ENSURE THAT THE INDIVIDUAL CONFINED TO THE BED IS POSITIONED PROPERLY WITHIN THE CONFINES OF THE BED. DO NOT LET ANY EXTREMITIES PROTRUDE OVER THE SIDE OR BETWEEN THE BED RAILS WHEN PERFORMING ANY FUNCTIONS.**
- **DO NOT USE UNAUTHORIZED SIDE RAILS.**
- **WARNING/ CAUTION LABELS APPLIED TO THE BED OUTLINE HAZARDS OR UNSAFE PRACTICES THAT COULD RESULT IN PERSONAL INJURY AND/OR PROPERTY DAMAGE.**
- **POWER AND WIRED HAND SET CORD MUST BE ROUTED AND SECURED PROPERLY TO ENSURE THAT**

THE CORD DOES NOT BECOME ENTANGLED AND EVENTUALLY SEVERED DURING USE. MAKE SURE ELECTRIC CORDS DO NOT GET TANGLED AROUND THE BED, SIDE RAILS OR LEGS DURING NORMAL OPERATION OF THE BED.

- **KEEP ALL MOVING PARTS FREE OF OBSTRUCTIONS (I.E. BLANKETS/SHEETS, HEATING BLANKETS/PADS, TUBING, WIRING, AND OTHER TYPES OF PRODUCTS).**

Meaning of the Safety Symbols

In these instructions the following safety symbols are used:



Warning about injuries to persons
Dangerous voltage. Life Threatening.



General danger. Injury or life hazard.



Warning about property damages
Possibility of damage to motor, material or environment.



OTHER SYMBOLS

Useful tip. For easier operation or better understanding of the unit.



Company name and address



Manufacturing date

IPX4

Protected against splashing water



Consult instruction manual



The item meets all the essential requirements of the relevant European Directive(s).
The 2797 refers to the Notified Body number who audit and certify the company.



This Symbol applies to European Union only as is defined as “Separate collection for electrical and electronic equipment waste per Directive 2002/96/EC in the European Union”



Type B device



Reference to the hazards in the instruction manual



Maximum Patient Weight



Safe Working Load - indicates maximum bed weight handling capacity



Potential Equalization (Equipotential Point)



Indicates the entity importing the medical device into the European Union.



Indicates a Medical Device.

The safety symbols used does not replace the text of the safety notes. Therefore, read the safety instructions and follow them exactly!

Table of Contents

WARNING 2

SPECIAL NOTES 2

NOTICE 2

DANGER/ WARNING/ CAUTION SUMMARY 2

Meaning of the Safety Symbols 3

Preface 7

About The Vitalgo Total-Lift Bed 8

 UNPARALLELED SAFETY 8

 Applied Parts 8

General Guidelines & Safety Instructions 9

 OPERATING INFORMATION 9

 ENTRAPMENT WARNING 9

 REPLACEMENT PARTS/ACCESSORIES GUIDELINES 9

 ELECTRICAL GUIDELINES 10

 RADIO FREQUENCY INTERFERENCE 11

 WEIGHT LIMITATIONS 12

 BEFORE PUTTING THE BED INTO OPERATION 12

 WARNINGS FOR USERS AND CAREGIVERS 12

Definitions of involved persons 13

Safety instructions for Technicians 14

Safety instructions for users and caregivers 14

VG-TLB425T Part Description 15

 Bottom View 16

 Upper View 16

Product description 17

 NORMAL OPERATING PROCEDURE 17

 SPECIAL FEATURES 17

 HEIGHT ADJUSTMENT 17

 LYING/SITTING POSITION 17

 IN TILTING / VERTICAL POSITION 17

CLASSIFICATION 17

Technical Specifications 18

 LIFETIME OF THE DEVICE 20

 RECLINING SURFACE FRAME 20

ELECTRIC ADJUSTMENT SYSTEM 20

DESCRIPTION OF MATERIALS..... 21

Label Locations 21

OPERATION 22

 CAUTION 22

 WARNING 22

 Side rail control..... 22

 Wired hand set..... 22

Control Functions..... 23

 MANUAL FUNCTIONS 23

 AUTOMATIC FUNCTIONS..... 24

 NURSE FUNCTIONS: TILTING 25

 SIDE RAIL CONTROL PANEL OPERATION 26

CLEARING ERRORS 26

Initialization of the Bed 27

Emergency and Manual Tilt Lowering 27

Drainage Bag Holder/ Din Rails..... 28

Patient Strapping System..... 29

Retractable Head Board..... 29

Mattress Attachment 30

Troubleshooting 31

Maintenance..... 32

 MAINTENANCE CHECKLIST 32

 ELECTRICAL INSPECTION AND MAINTENANCE 32

 RECHARGEABLE BATTERIES MAINTENANCE 33

 Cleaning and Disinfecting 33

Total Lift Bed – Weight Bearing Control System 35

Low Air Loss Mattress System..... 37

 Operating Instructions 39

 CPR FUNCTION 41

TLB Total Drive System (TDS) Instructions for use 43

(Optional) 43

 Device Overview 43

 General Operation..... 43

 Buttonology and Function 43

 Battery Charge Indicator 44

 Forward / Reverse 44

TDS Braking Systems..... 44

Steps for transporting the bed 44

CHARGING THE DRIVE SYSTEM BATTERIES 45

Basic Safety Instructions 46

Digital Inclinometer – Angle Sensor (optional) 47

Declaration of Electromagnetic Environment guidelines 48

LIMITED WARRANTY 51

ABOUT VITALGO SYSTEMS LTD..... 52

Preface

Dear customer,

Thank you for the confidence you have shown in VitalGo Systems products.

The Total-Lift Bed™ has been factory checked for electrical safety. All functions have been checked and were operating perfectly before delivery

Please take your time to read this manual carefully before operating the bed. This manual applies to normal use of the bed and assembly and maintenance. It is also a practical reference guide. Keep the instructions in a handy place. These instructions provide information for the operator and user regarding the convenient handling and safe operation of the bed.

We hope that the VitalGo Total-Lift Bed™ enables you to promote optimal patient mobility and comfort, and maximal caregiver safety in getting your patients out of bed.

VitalGo Systems LTD.

Note: It is the responsibility of the Facility/ Caregiver / to report any serious incident that may occurred, in relation to the Bed, to the Distributor, manufacturer or Manufacturer Representative and the component authority of the member state in which the incident has occurred.



About The Vitalgo Total-Lift Bed™

The Total-Lift Bed™ sets new standards in patient and caregiver safety, treatment and comfort.

The Total Lift Bed™ is a Bed and so much more providing many advantages over conventional beds.

The revolutionary design allows the bed to raise the user to a fully standing position and all positions in between including chair positions.

Among all its clinical obvious benefits, the Total Lift Bed™ is the best instrument for Early Mobility, safe patient handling and safe lifting.

The Total Lift bed™ is ideal for use in any kind of Medical facility and is especially for –

- Acute Care.
- Burn Units.
- Orthopedic patient population.
- Early Mobility
- Progressive Mobility.
- Safe patient Handling and Safe Lifting.
- Rehabilitation
- Neurologic patient population.
- Fall Prevention

With just a press of a button you can bring the patient to any position desired.

The Patented technology of the total Lift Bed™, moves the Foot Lifter™ towards the feet of the patient / user, and only when making contact will start the tilting function, thus preventing any danger of sliding in bed. While the bed tilts, when in proper angle the Foot Lifter™ will gradually move down so when the bed is in fully standing position the Foot Lifter will be parallel to floor allowing to simply walk out of bed, with or without assistance.

The patient can be just tilted, for treatment, in any desired angle, for as long as needed. The Total Lift Bed™ has all possible bed and chair positions.

The Total Lift Bed™ can come with powered air mattress and high quality nonpowered mattress.

WEIGHT BEARING CONTROL – The Total Lift Bed is the only real true “Weight Bearing control device”, knowing the exact amount of pressure transfer to the feet and through body of the patient / user, which can be increased or decreased by changing the beds angle.

The Total Lift Bed™ has all safety features and is FDA and CE registered conforming with the EN/ IEC 60601-2-52 and the Assessment Guidance to Reduce Entrapment.

UNPARALLELED SAFETY

Safety is the top priority of all Vitalgo products. The Total-Lift Bed™ incorporates numerous safety features and mechanisms and meets or exceeds the highest standards for medical electric beds.

The Total Lift Bed is a FDA and CE Registered. The Total Lift Bed is a “Mobile Bed “ and has been tested and conformed according to IEC 60601-1:2005/A1:2012 and/or EN60601-1:2006/A1:2013 Ed. 3.1 and 60601-2-52:2009/A1:2015, ; IEC/EN 62366-1:2015; IEC/EN 60601-1-6:2010/A1:2013/A1:2015 and EN60601-1-2, 2014 (4th Edition)

The integrated safety features include:

- Exclusive self-adjusting Foot-Lifter™ – Automatically moves up to rest under the user’s feet prior to the bed tilting into an upright position, preventing the user from sliding down the bed. Embedded micro-switches ensure the user is properly positioned and that when the bed is in an upright position, the user’s feet are at ground level.
- Safety Rails (optional) – Can be added to the upper and lower part of the bed, on one or both sides. Vitalgo has adopted all FDA clinical guidance to reduce Entrapment.
- Electronic braking – Casters are electronically lowered to allow mobility and raised to secure stability; they are automatically raised before the bed can be tilted or the sitting/reclining positioning adjusted. The casters have Total Lock function and one directional lock for easy transportation of bed.

Applied Parts - defined as the mattress platform and metal parts in the bed.



General Guidelines & Safety Instructions

OPERATING INFORMATION

DO NOT use near explosive gases.

Keep the product a minimum of 12" away from any direct heat source.

Close supervision is necessary when this product is used by or near children or people with disabilities.

Check all parts for shipping damage and test before using. In case of damage, DO NOT use. Contact a qualified technician for further instruction.

After any adjustments, repair or service and before use, make sure all attaching hardware is tightened securely.

DO NOT let any individual underneath the bed or in between the raised bed frame components at anytime.

When bed is not to be used for an extended period, unplug electric bed from the wall outlet.

When operating the bed body weight should be evenly distributed over the surface of the bed. DO NOT lay, sit or lean in such a way that your entire body weight is placed only on raised head or foot sections of the bed.

This includes when assisting the user in repositioning or transferring in or out of bed.

This Warning DOES NOT apply to the Foot Lifter™.

When operating/moving beds, always ensure that the individual utilizing the bed is positioned properly within the confines of the bed. DO NOT let any extremities protrude over the side or between the bed rails when performing these functions.

If the unit is not working properly, call a qualified technician to examine the unit and repair it.

Keep all moving parts, including the main frame, mattress deck (head and foot sections) and all drive shafts, free of obstruction (i.e. Blankets/sheets, heating blankets/pads, tubing, wiring, etc. and other types of products using electric cords which may get tangled around the bed, side rails or legs) during operation of the bed.



ENTRAPMENT WARNING

Proper patient assessment and monitoring, and proper maintenance and use of equipment is required to reduce the risk of entrapment. Variations in bed rail dimensions, and mattress thickness, size or density could increase the risk of entrapment.

Visit the FDA web site at <http://www.fda.gov> to learn about the risks of entrapment.

After any adjustments, repair or service and before use, make sure all attaching hardware is tightened securely. Side-Rails with dimensions different from the original equipment supplied or specified by the bed manufacturer may not be interchangeable and may result in entrapment or other injury. Mattress MUST fit bed frame and assist rails snugly to reduce the risk of entrapment.



REPLACEMENT PARTS/ACCESSORIES GUIDELINES

VitalGo products are specifically designed and manufactured for use in conjunction with VitalGo accessories. Accessories designed by other manufacturers have not been tested by VitalGo and are not recommended for use with VitalGo products.

Use ONLY VitalGo's Total-Lift Bed™ supplied mattress and connect it to the bed frame according to the instructions in this manual (see page 28)

Bed rails can be deformed or broken if excessive side pressure is exerted on the bed rails. These bed rails are

used for the purpose of preventing an individual from inadvertently rolling out of bed.

The bed rails are NOT intended nor may be used for restraint purposes. If an individual is capable of injuring himself/herself, a physician or a healthcare professional should be consulted for alternative means of safe restraint.

DO NOT use the side rails as push handles for moving the bed.

If the patient assessment concludes that the patient's condition increases the chance of entrapment, the bed MUST be in the flat position when left unattended.

Trapeze units are to be used only for assisting the patient in repositioning or transferring into or out of bed. Not used while bed is in operation and must be moved away from the bed as soon as the patient finished using them.

Replacement mattresses and bed side rails with dimensions different than the original equipment supplied or specified by the bed frame manufacturer are not interchangeable.

Variations in bed side rail design, width and thickness or firmness of the mattress could cause/contribute to entrapment.

Use only authorized VitalGo replacement parts and/or accessories otherwise the warranty is void. VitalGo will not be responsible for any damage or injury that may result.

ELECTRICAL GUIDELINES



DANGER

Connect the bed directly to an electrical outlet. Do not use extension cords and/or multiple outlet extension cords.

Use of three prong adapters can result in improper grounding and present a shock hazard to the user.

NEVER operate if the unit has a damaged cord or plug. If it is not working properly, call a qualified technician for examination and repair.

Keep all electrical cords away from heated or hot surfaces.

Ensure all cables and cords are routed such that they will not become entangled or pinched. Otherwise damage or injury may result.

DO NOT unplug power cord from junction box.

The Hand pendant and power cords must be routed and secured properly to ensure that the cords DO NOT become entangled, pinched and/or severed during operation of the electric bed.

Refer servicing to qualified personnel only. Grounding reliability depends upon a properly grounded wall outlet.

REPAIR OR SERVICE INFORMATION

DO NOT open assemblies such as the motors, pendant, junction boxes.. No user serviceable parts are inside. Only qualified technicians (qualified by Vitalgo) are permitted to repair these parts. If unqualified individuals perform any work on these beds, the warranty is void.

Unplug the power cord from its power source before performing any maintenance on the bed.

DO NOT unplug the power cord from the junction box. Damage to cord will result.

RADIO FREQUENCY INTERFERENCE

Electronic equipment may be influenced by Radio Frequency Interference (RFI). Caution should be exercised with regard to the use of portable communications equipment in the area around such equipment. If RFI causes erratic behavior, unplug the electric bed IMMEDIATELY. Leave unplugged while transmission is in progress.

 **WARNING:** Use of this equipment adjacent to or stacked with other equipment should be avoided because it could result in improper operation. If such use is necessary, this equipment and the other equipment should be observed to verify that they are operating normally.

 **WARNING:** Use of accessories, transducers and cables other than those specified or provided by the manufacturer of this equipment could result in increased electromagnetic emissions or decreased electromagnetic immunity of this equipment and result in improper operation.

 **WARNING:** Portable RF communications equipment (including peripherals such as antenna cables and external antennas) should be used no closer than 30 cm (12 inches) to any part of the [ME EQUIPMENT or ME SYSTEM], including cables specified by the manufacturer. Otherwise, degradation of the performance of this equipment could result.

 **NOTE** The EMISSIONS characteristics of this equipment make it suitable for use in industrial areas and hospitals (CISPR 11 class A). If it is used in a residential environment (for which CISPR 11 class B is normally required) this equipment might not offer adequate protection to radio-frequency communication services. The user might need to take mitigation measures, such as relocating or re-orienting the equipment

 An exemption has been used and that the equipment has not been tested for radiated RF IMMUNITY over the entire frequency range 80 MHz to 6 000 MHz.

 **WARNING:** The ME equipment has been tested for radiated RF immunity only at selected frequencies –

Radiated immunity test specifications		
Frequency	Power	Test distance
164.12MHZ	15V/m at 1m	Tested at 0.1m
826.8Mhz	5V/m at 1m	Tested at 0.1m

 **WARNING:** This equipment has been tested for radiated RF immunity only at selected frequencies, and use nearby of emitters at other frequencies could result in improper operation”

 **Caution:-** The Bed is a “Class A” Equipment (As defined in IEC 60601-1-2) and is not intended for use in residential environment and may not provide adequate protection to radio reception in such environment.

Declaration of Electromagnetic Environment guidelines – see pages 43-45

WEIGHT LIMITATIONS

The total weight limit of the VitalGo Total-Lift Bed™ VG-TLB425V/T is 425 pounds (193Kg) patient weight. DO NOT permit more than one person on/in the bed at any time.

When the bed is an operation body weight should be evenly distributed over the surface of the Total-Lift Bed™.

DO NOT lay, sit or lean in such a way that your entire body weight is placed only on raised head or foot sections of the bed.

This includes when repositioning or transferring in or out of bed. This Warning DOES NOT apply to the Foot Lifter™.



BEFORE PUTTING THE BED INTO OPERATION

Read these instructions carefully in order to avoid damage or incorrect operation. Before using the Total-Lift Bed™, the user shall ensure that it is in Proper working order and free of defects, and be aware of the instruction manual. This applies also to all accessories.

The VitalGo Total-Lift Bed™ was checked by an independent examining institute. As with all technical, electrical devices improper handling can lead to damage and/or injury.

Observe your obligations as an operator in accordance with medical devices Operators guidelines for Medical Products in order to ensure a dependable and safe operation of this medical device without endangering patients, users and third parties.

This manual contains safety guidelines, which must be observed. All persons who work with the VitalGo Total Lift Bed™ must familiarize themselves with these instructions and follow the safety guidelines.

Whenever the Bed is placed for operation, in order to ensure proper operation, the following procedures should be taken.

- a. Connect bed to outlet.
- b. Check green light is on the power supply.
- c. Assure all plugs are in place
- d. Perform clear error (buttons 3+4)
- e. Perform initialization (buttons 1+2)
- f. Assure bed is in the correct position using the picture -----
- g. Press CPR bring bed to FLAT position.
Bed is now ready for operation with patient.



WARNINGS FOR USERS AND CAREGIVERS

1. Position the power cable in such a way that during normal operation of the bed the cable will not be stretched, driven over or interfere with moving parts of the bed.
2. Before any relocation of the bed it is imperative that the power cable is pulled from the wall socket and that the cable cannot fall or be dragged over the floor.
3. Check the power cord regularly for damage (abrasions, exposed wires, kinks, pressure marks, etc.) In particular:
 - After every larger mechanical strain (e.g.: Rolling over the power cord with the bed or with an equipment cart.
 - After a strong pulling or bending load caused by the bed rolling away with the power cord still attached to the wall outlet.

- After relocating/moving and before plugging in the power cable.
 - During prolonged operating by the user. Do not use the area under the Total-Lift Bed™ as a storage area for anytime.
4. Lower the bed to sleeping positions (see Page 23) and lift side-rails if present when leaving the patient unattended. This reduces the risk of injury to the patient getting in and out of the bed (consider restrain laws in the different countries).
 5. Keep the wired hand set safe from accidentally falling during non-use (Hang it on the its holder). Take care that the cable is not damaged by the moving parts of the bed.
 6. To protect the patient and especially children from unintentionally operating the Wired hand set, place it beyond their reach.
 7. Place the wired handset out of the patient's reach when:
 - The patient is not able to control the bed safely or he is unable to get out of dangerous positions without help.
 - When bed has functioning problem.
 - Unsupervised children are in the room with the Total-Lift Bed™.
 - The wired handset is only to be used by authorized personal.
 8. Initialization functions can only be performed by a properly trained personal.



Disposable of the Medical Equipment

The Total Lift Bed parts are supplied from environmentally aware manufacturer that complies with the Waste of Electrical and Electronic Equipment (WEEE) directive 2002/96/CE. The Total Lift Bed may contain substances that could be harmful to the environment if disposed of in places that are not appropriate according to legislation. Please be environmentally responsible and recycle this bed through your recycling facility when the bed has reached the end of its service life. For proper disposal of the device please consult/contact/check with the appropriate authorities/regulatory agencies of the country where the Bed is located

Definitions of involved persons

In this manual the following persons are involved:

TECHNICIAN

A person trained and authorized by Vitalgo to service the bed, or is working for VitalGo's distributor and was trained by distributor with VitalGo's guidelines.

The technician is responsible for instructing the user in the proper use of the unit.

CARE GIVER

Caregivers are persons who as a result of training and experience are authorized to operate the *Total-Lift Bed™*. The care giver can recognize and avoid possible dangers and judge the clinical condition of the patient.

USER

In this manual a the user is:

In Healthcare facilities – Authorized person by the facility to take care of Patients within the facility and was trained to use the Total Lift Bed- “Trained Personal”. “User” may also refer to the Patient himself.

SPECIALIST STAFF

Specialist staff are employees of the suppliers, or anyone certified by the company, who are authorized as a result of their education and training to deliver, assemble, dismantle and transport the Total-Lift Bed™. Furthermore, they are familiar with the regulations for cleaning and disinfecting the unit.

Safety instructions for Technicians

Before first use, instruct every user in the safe operation of the Total-Lift Bed™ in accordance with these safety instructions, which must be supplied along with the unit.

Call attention to the dangers of improper use of the unit, especially in regards to the electrical drives and side rails.

When the Total-Lift Bed™ is located in institutions (e.g.: Hospitals, nursing homes etc.) The unit should only be operated by properly trained personnel.

When in home use the Total-Lift Bed™ should only be used by users who read and understood thoroughly the operation manual.

During long term use it is recommended that the Total-Lift Bed™ be inspected for function and visible damage at regular intervals (Recommendation: yearly, if not on a rental fleet, and after every delivery in case on rental fleet. (see Maintenance Checklist - Page 27).

Connect the bed directly to an electrical outlet. Do not use extension cords and/or multiple outlet extension \ cords.

When attaching other equipment (e.g. compressors for positioning systems) make sure that they are mounted and can function in a secure and safe manner (based on manufacturer safety recommendations).

Do not put multiple outlet electrical extensions under the bed. Leaking liquids can cause a fire hazard. Pay special attention to: Secure locations for all wiring, cables, tubes, etc.

For further information please contact the manufacturer of the accessories or VitalGo Systems directly. Make sure that your personnel follow the safety instructions.

Safety instructions for users and caregivers

Let the technician instruct you in the safe use of the bed.

Before each use make sure that the bed is in proper working order.

Take care that no obstacles, such as furniture or slanted ceilings interfere with the adjustment functions (See clearing page 19-20).

Important!

Patients under 5' (152cm) tall, should make sure their feet touch the Foot Lifter™ before entering tilting position. Patient over 6.7' cannot use the tilting function of the bed.

Pay attention that when using additional electrical components, such as patient lifts, reading lights or compressors for positioning systems that their electrical cords do not get entangled or damaged by the moving parts of the bed.

Connect the bed directly to an electrical outlet. Do not use extension cords and/or multiple outlet extension cords.

Make sure that when attaching other appliances (e.g. Compressors for positioning systems) that a safe mounting and function is guaranteed.

Remove moveable items from the bed before starting the tilting operation. Make sure you can see the hand control functions.

Do not put multiple electrical outlets under the bed. Leaking liquids can be a fire hazard. Pay special attention to securely locating all wiring, cables, tubes, etc.

For further information please contact the dealer or person from which you purchased the bed or VitalGo Systems directly.

Take the bed out of operation if damage or a malfunction is suspected: Immediately unplug the electrical plug from the wall outlet; Call a qualified technician.

Do not use the bed until a technician has inspected the bed and approved it for use.

VG-TLB425T Part Description

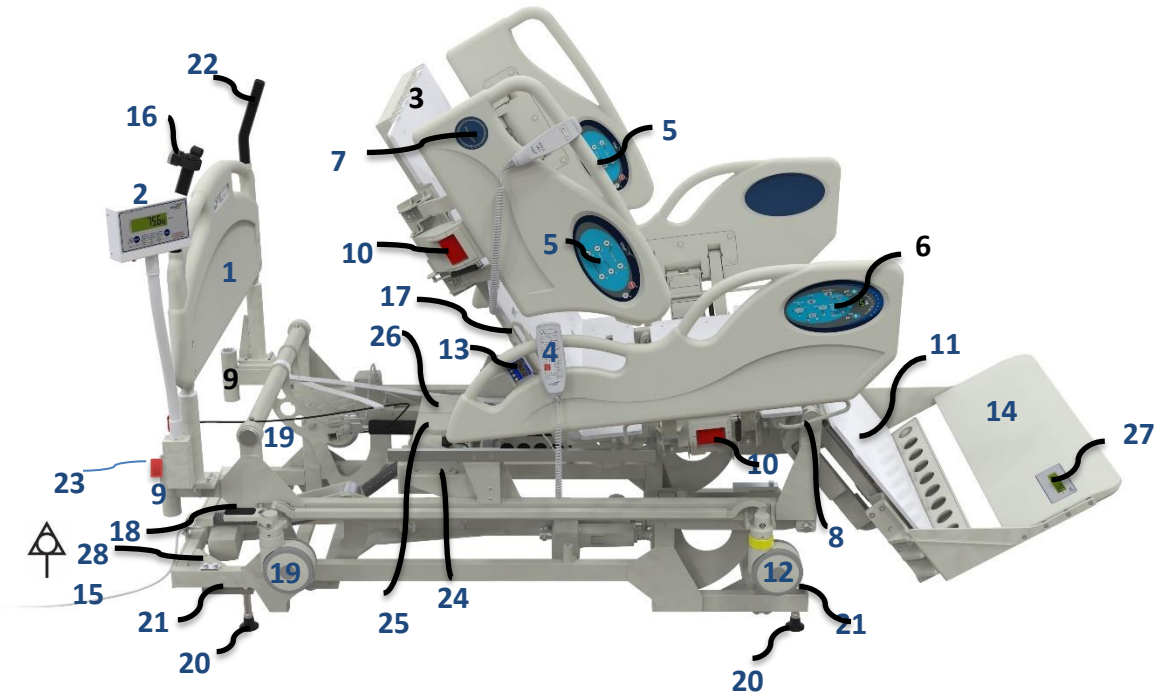

1. Headboard.
2. Scale display.
3. Backrest
4. Handset
5. Side-Rail control panel.
6. Powered Mattress control panel.
7. Inclinator.
8. Strap Holder (leg).
9. IV/ Trapeze holders.
10. Side-Rail Release.
11. Leg-rest.
12. Conductive Caster.
13. Digital Inclinator (optional).
14. Footlifter (adjustable).
15. Power cord.
16. Total Drive Operation. (Throttle & On/Off.
17. Strap holder.
18. Break lock / Directional lock.
19. Total lock caster.
20. Leg Support.
21. Load Cell.

- Total Drive handles.
23. Tilt quick release handle.
24. Controller.
25. Power Supply.
26. Battery backup.
27. Weight Bearing display.
28. Potential equalization pin.

- 29. Electric connections box.
- 30. Foot Lifter move stoper. (red button).
- 31. Total Drive.
- 32. Tilt Quick-release gas piston.
- 33. Hi/Low Actuator.
- 34. Foot-lifter actuator.
- 35. Leg-rest actuator.
- 36. Tilt actuator.
- 36. Back-rest actuator.
- 37. Power Connection.
- 38. Tilt quick release cable.
- 39. Actuator connection to controller.
- 40. Trendelenburg Actuator.

Bottom View

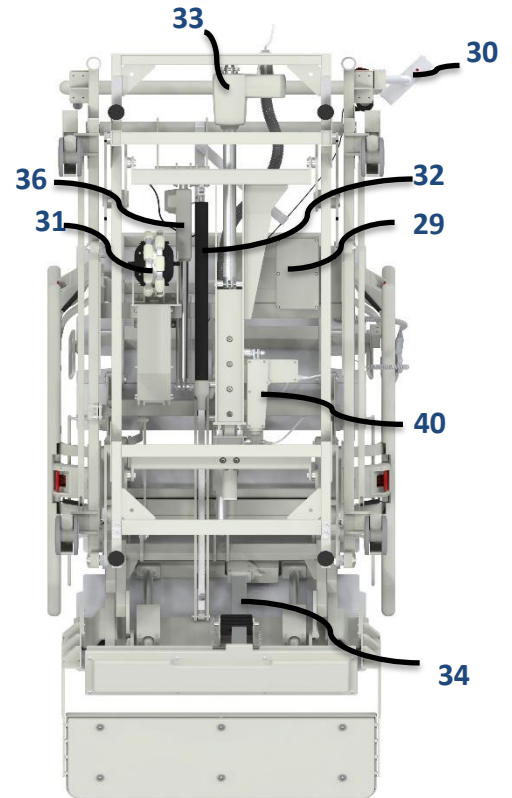

Upper View (some parts removed for better vision)

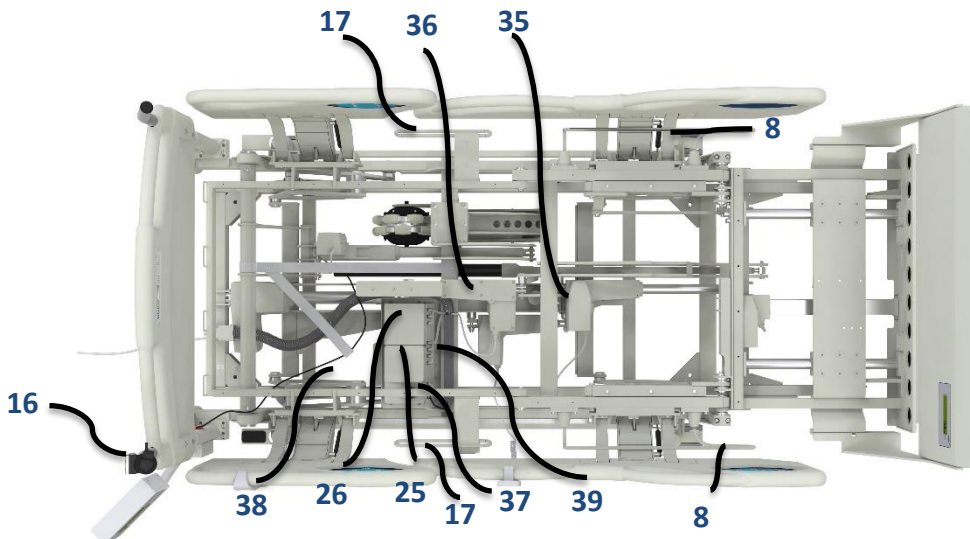

Product description

NORMAL OPERATING PROCEDURE

The Total Lift Bed, Hereafter called bed, is a, one of its kind, Tilting Hospital Bed which can take the user to a standing position, seating position with legs down/up and many other positions as described in this manual. The Total Lift Bed has a state of the art programmable system, which allows many functions and possibilities, for the safety, comfort and independence of the user and Care giver.

The Total Lift Bed facilitates compliance with the National Institute of Occupational Health (NIOSH) and the American Nurses Association (ANA) standards. The Bed can be used by one Care Giver.

The Total Lift Bed can help in numerous medical conditions.

Total Lift Bed safe working load is 616lb(280 kg) and max patient capacity is 425lb(193 kg).

For users under 5' (152cm), please make sure that the user feet is touching the foot-lifter, in order to avoid dangerous sliding of the patient.

Always secure the patient using the strapping system, when using the tilting function.

The Total Lift Bed may only be operated under the operating instructions laid out in this instruction manual. Any other use is deemed to be inappropriate.

SPECIAL FEATURES

HEIGHT ADJUSTMENT

Electrical height adjustment of the reclining surface from approx. 18”(46cm). to 29.5”(75cm) (± 15 mm).

Electrical movement of the Foot Lifter™ is from approx. 8”(20cm). into the bed (over the mattress) to about 4”(10cm) outside the bed.

LYING/SITTING POSITION

Electrical adjustment of the backrest from 0° to about 63° (± 5 °).

Electrical adjustment of the thigh rest from 0° to about 6.5° (legs down) (± 3 °) and from 0° to about 25° (legs up). (± 3 °)

Electrical adjustment of the Leg rest from 0° to about 54° (± 3 °).

IN TILTING / VERTICAL POSITION

The bed joints work in synchronization bringing the bed to around 82° (± 3 °).

The bed is driven with four castors which become functional only when bringing the bed to “WHEELS” position accessible through the hand set.

CLASSIFICATION

EU - The Bed is a Medical Device for Hospital Use and is classified as IM with B type of applied part, continuously operated, movable and without signal input output parts. Water resistance comply with IPX4 the device is not intended for use in presence of flammable mixtures.

FDA - Device Class II, adjustable electric hospital bed, AC-powered regulation number 880.5100

The tested product satisfies the requirements of IEC 60601-1:2005/A1:2012 and/or EN60601-1:2006/A1:2013 Ed. 3.1 and 60601-2-52:2009/A1:2015.; IEC/EN 62366-1:2015; IEC/EN 60601-1-6:2010/A1:2013/A1:2015 and EN60601-1-2, 2014 (4th Edition)

Technical Specifications

Bed Weight - (Including Low Air Loss mattress) 315kg (695lb).

Bed Dimensions:

(Possible error ± 15mm)

- Length:**

Overall Length (in regular position).....85.83” (218cm)

Overall Length – Fully extended (Foot lifter out).....89.76” (228cm)

- Width:**

Overall Width – With Side -Rails.....40.95” (104cm)

- Height:**

Low Position – deck to floor.....20.67” (52.5cm)

High Position – deck to floor.....29.72” (75.5cm)

- Clearance:**

From frame to floor.....1.38” (3.5cm)

In Standing Position:

From top of Bed to floor.....80.25” (203.83cm)

- Mattress Dimensions–**

Length.....78.75” (200cm)

Width.....35” (89cm)

Height.....6” (15.20cm)

- Casters & Breaking System:**

Diameter.....5” (12.70cm)

Smart Break™ – Casters are lifted from floor when not in “Wheels” position Each

Side of bed has central locking break system (one side)

Directional Lock – On one caster for easy maneuvering of bed.

This caster is Anti-static.

- Foot Lifter:**

Moves over Mattress 7.90” (20cm) towards Head Rest.

Moves out of Bed – 3.95” (10cm).

Moves up in Chair Position until contact with feet or

Max. of 7.90” (20cm).

- Positions:**

Sleeping

Chair Position (Legs down with foot lifter support) with reclining.

Leg Rest - Up & Down.

Back Rest Up.

Trendelenburg (In 425T)

Tilting positions up to Standing Position.

- Control:**

Control by Smart pre-programmed Hand Set.

Tilting function is locked for Nurse / Caregiver use only.

Automatic functions for seating with legs down and reclining, including foot support.

Hand Set works with constant press only.

Additional control, for basic functions, on side-rail, for patient and care giver.



- Strapping System:**

One strap in Waist area.

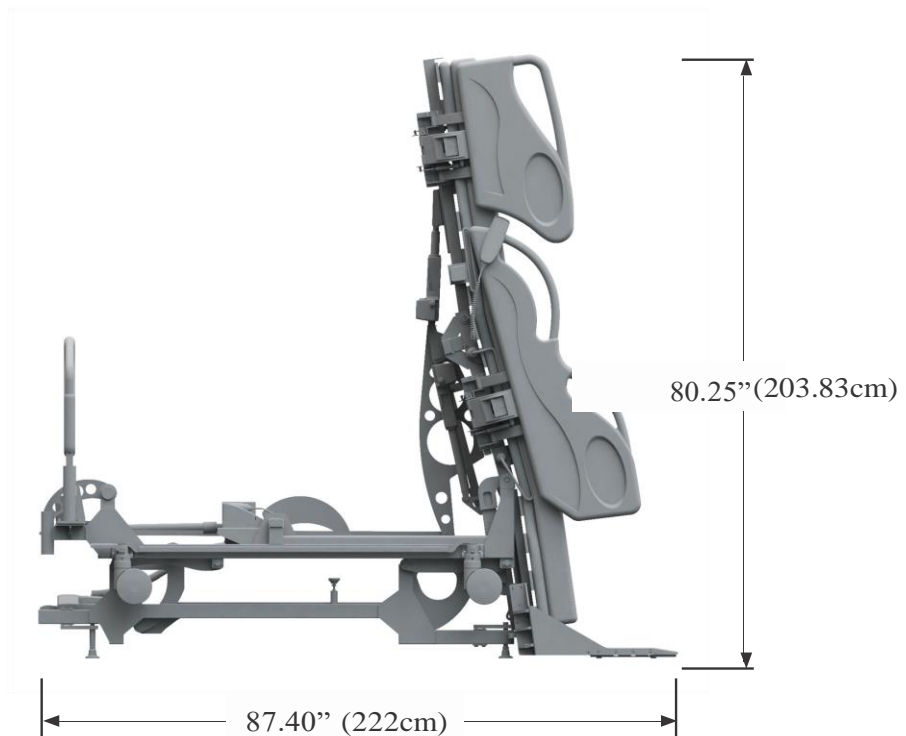
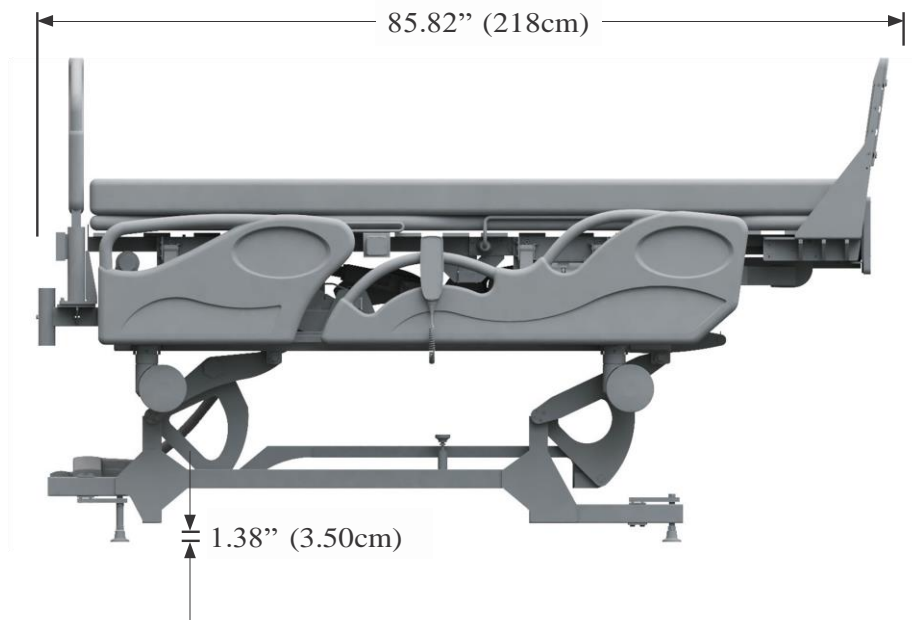
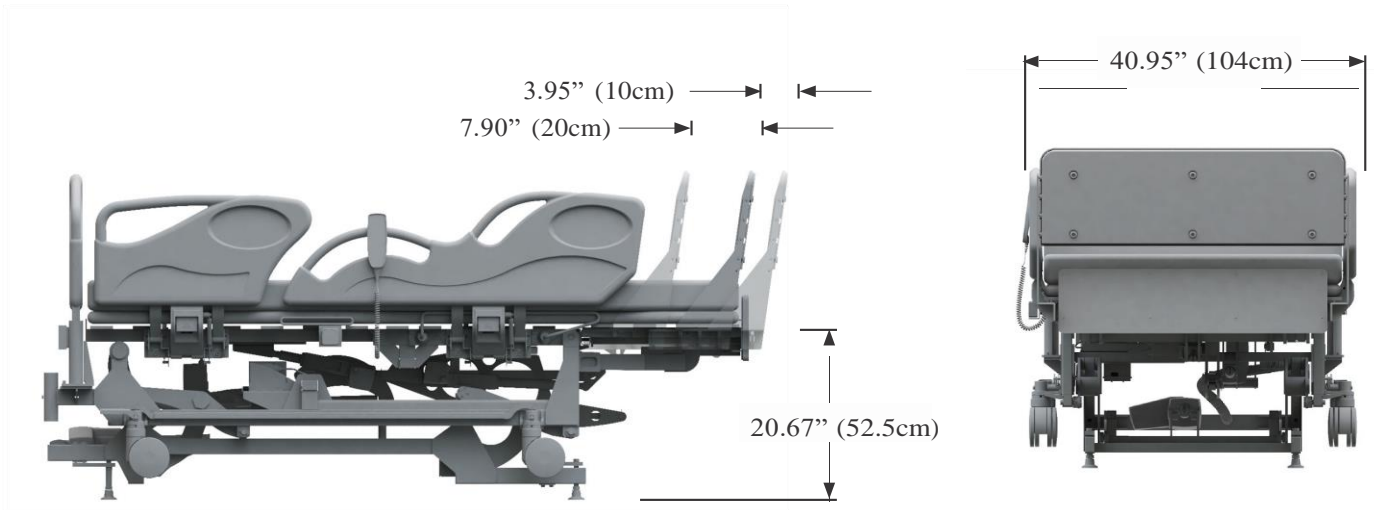
Up to three straps in lower extremities area

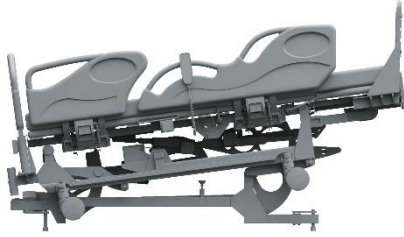



- **Maximum user weight:** 425 lb.(193kg) 
 - **Maximum Safe loading capacity –** 616lb (280kg) 
 - **Casters/ brakes:** Electrically controlled and individual mechanical break on each caster.
 - **Electronic Wired hand set: Integrated 12 functions + caregiver function**
- Electricity requirements:** Voltage - 100/240V~AC
 Max Frequency 50/60HZ
 Power Consumption Max 350W

Environmental condition	For Use	For Transport & Storage
Ambient Temperature -	5°C (41°F) to 40°C (104°F)	-40°C (-40°F) to 70°C (158°F)
Relative Humidity Range -	20% to 80% non-condensing	10% to 95% non-condensing
Atmospheric Pressure Range -	700 hPa to 1060 hPa.	500 hPa to 1060 hPa.

- **Battery Backup –** Should be charged for 24 hours and is good for a few cycles of bed operation.

LIFETIME OF THE DEVICE

The TLB425T has been tested by a laboratory to assure compliance with IEC60601-2-52:2009/A1:2015 and has concluded that based on the result of the testing conducted that the bed has the life expectancy of approximately 8 years, in the abundance of caution, for the purposes of compliance with all regulatory and ISO13485:2016 requirements, Vitalgo has designated 7 years to be the expected life time of the TLB425T bed.

RECLINING SURFACE FRAME

The reclining surface frame has four sections: a movable backrest, a moveable thigh rest, a movable leg rest and a movable Foot Lifter™. All parts can be adjusted by electric motors. The horizontal height of the reclining surface can be adjusted and inclined. All adjustment functions are controlled by a Wired hand set and basic controls are available on the head-side, side rails, from both sides.

The mattress base of the Total-Lift Bed™ consists of washable HPL;

The Total-Lift Bed™ has side rails on both sides which can be raised as a barrier or removed when not needed. This safeguards the patient from accidentally falling out of the bed.

The rails are designed according to FDA and CE recommendation to avoid entrapment (Hospital Bed System Dimensional and Assessment Guidance to Reduce Entrapment).

ELECTRIC ADJUSTMENT SYSTEM

The electrical adjustment system of this bed is error protected, flame-retardant (V0) and consists of An external transformer unit which consists of a power cable, the transformer, and a low voltage connection cable. The transformer creates a 24volt low voltage, which is safe for patient and user. The transformer supplies all drive motors with the 24volt safety low voltage. The connecting socket on the bed frame is moisture proof.

DESCRIPTION OF MATERIALS

The bed is mostly constructed out of steel sections, their surfaces are mostly powder coated and some are painted. All parts comply with the RoHS (Directive 2002/95/EC,) regulatory requirements.

The washable HPL are made of HPL (High Pressure Laminate).

Foot-Lifter™ is made of ABS plastic.

Side Rails and Headboard are Polypropylene.

All surfaces are harmless to skin contact.

Label Locations

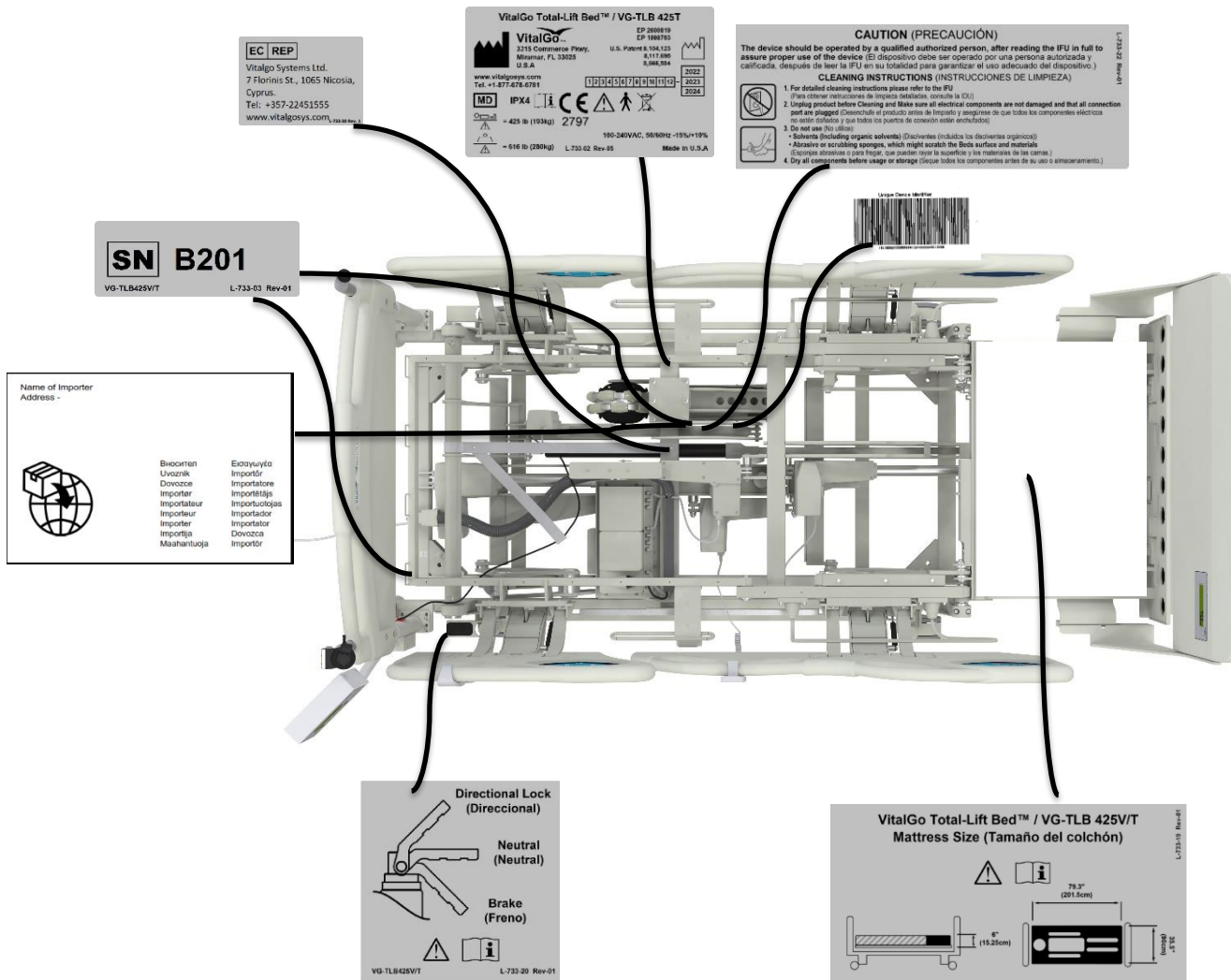

OPERATION

CAUTION

Allow a slight pause between adjustments and avoid pressing multiple buttons at the same time unless indicated. If wired hand set buttons are depressed too rapidly or wrong button combinations are pressed at the same time, the desired feature may not activate.

Simply release the wired handset button, permit a slight pause and then activate the next operation. Before placing the bed into use, test it by operating it through all phases of its operation.

If any problems arise during the test, recheck all electrical connections and mechanical hook ups.

WARNING

DO NOT place wired hand set under or between objects. This may unintentionally press the buttons and may cause injury or damage.

Side rail control

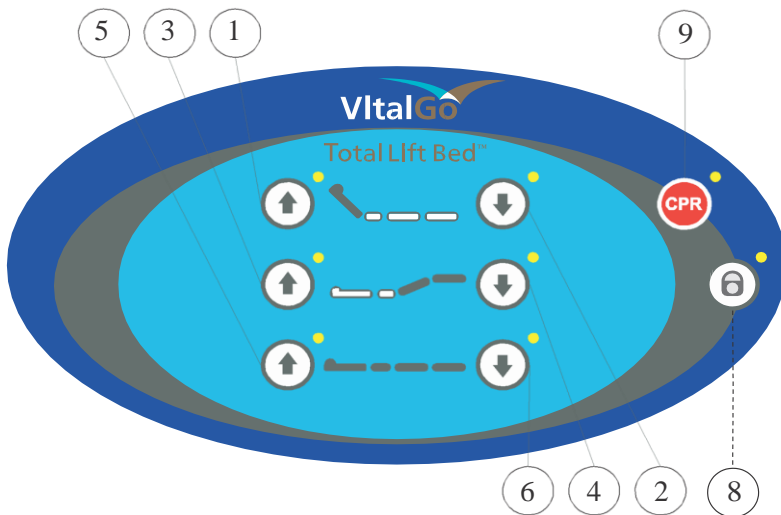

Wired hand set

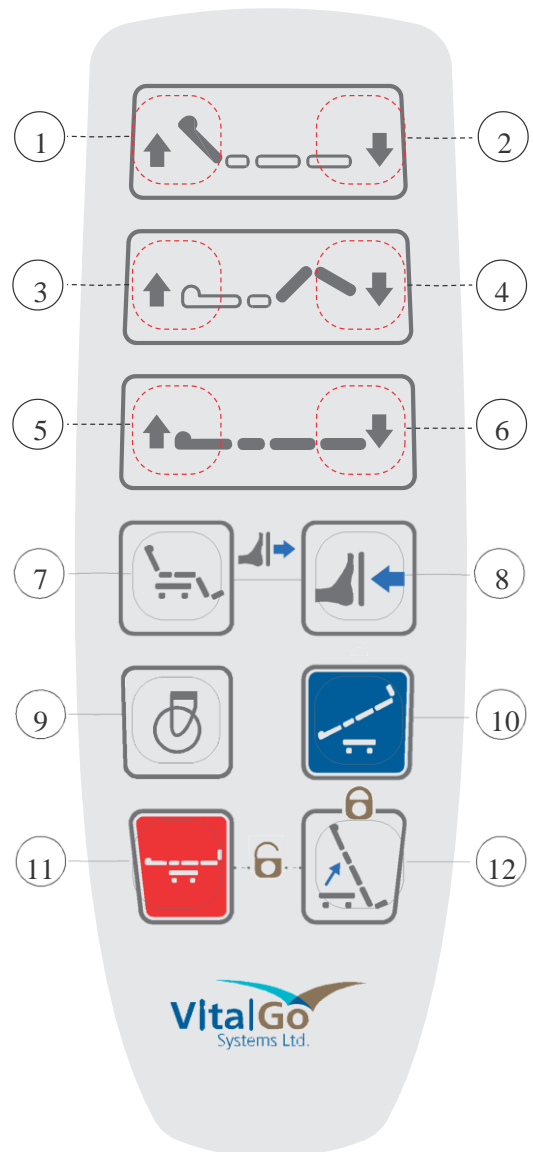

Control Functions



Please Note: At the end of the movement of each function (unless stated otherwise) two beeps will be heard. Press button continuously to perform each function.

The Total-Lift Bed™ has a state of the art program system which is controlling actuators in perfect synchronization in order to achieve safe and comfortable movements and positions.

When pressing one function it may make a movement of another part of the bed, this is normal and designed this way.

MANUAL FUNCTIONS

• ADJUSTMENT OF THE BACK REST –

(1&2) Pressing on Button (1) will raise the Back Rest; Pressing on Button (2) will lower the back rest.

Special Automatic Movements –

- A. When raising the Back Rest (1) the Foot Lifter™ will move out, in order to avoid pressure on feet.
- B. When lowering the Back Rest (2) the Foot –Lifter will not close back.
- C. In order to close the Foot Lifter™ to its center position use function(8) – Footboard In.
- D. In case that the Leg-rest is above its center position and the Backrest is raised to an Upright position, it might be that the Leg-rest will move down, in order to avoid pressure on the back and pelvis.
- E. When reaching the end position of the function, two beeps will be heard as a confirmation.

• RAISING & LOWERING LEG-REST – (3&4)

Pressing Button (3) will raise the Leg-rest; Pressing Button (4) will lower the Leg-rest.

Special Automatic Movements –

- A. When Raising the Leg-rest, the Foot Lifter™ will move out, in order to avoid pressure on the feet and legs.
- B. When Lowering the Leg-rest, the bed will raise itself to the level which will enable the Leg-rest to get as low as possible.
- C. When moving the Leg-rest down after the Leg-rest will reach its lowest position, the Foot Lifter™ will move towards your feet, after touching your feet it will retreat a bit to avoid pressure on your feet and legs, but yet giving a comfort support to the feet.
- D. In case that the Backrest is in Upright position and the Leg-rest is raised in a way it might create pressure on the back and Pelvis, the Backrest will move down automatically. The user can adjust the optimum position by using the buttons (1)-(2) & (3)-(4).
- E. When reaching the end position of the function, two beeps will be heard as a confirmation.

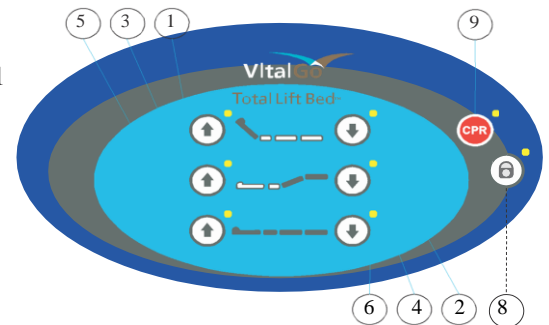
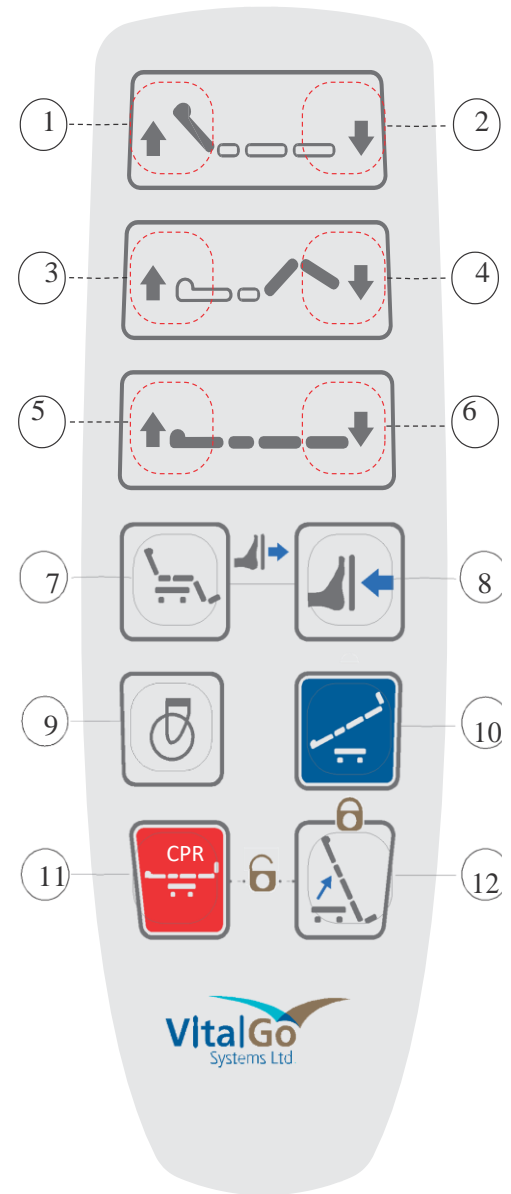

- **RAISING & LOWERING THE BED HORIZONTALLY – (5&6)**

Pressing Button (5) will raise the Bed horizontally up to a maximum height of 29.5”(75.5cm) (Without Mattress).

Pressing Button (6) will lower the bed Horizontally to a minimum height of 20.67”(52.5 cm) (Without Mattress).

- *Special Automatic Movements –*

If the Leg-rest is lower than the horizontal position of the bed and the Bed will be lowered, the Leg-rest will automatically be raised to the horizontal position.

- **FOR LOWEST SLEEPING POSITION**

In order to lower the Bed, press Wheel function (9).

Be aware of the wheels moving down. It is possible to stop at any height. After reaching wheels position two beeps will be heard.

Press button (11 - CPR) and the lowest sleeping position will be reached 18”(46 cm) (Without Mattress).

- **MOVING THE FOOTLIFTER –**

A. Pressing button(8) will move the footlifter towards the hed. As long as button(8) is pressed, the footboard will move, until it's end position. To stop movement, stop pressing.

B. Pressing buttons(7)&(8) together, will move the footboard out.

In both cases, when two beeps are heard, that indicates that the end position of movement has been reached.

- **WHEELS POSITION:**

A. Pressing Button (9) will lower the Bed and activate the Wheels. For completing and reaching the end position of this function, hold button 9 until two beeps will be heard as a confirmation.

B. By pressing buttons 5, or 11 ,the bed will be raised and deactivate the wheels position.

C. On the Side-Rail control Pressing buttons 8 (Lock) and 9 (CPR) together, will move the wheels down.

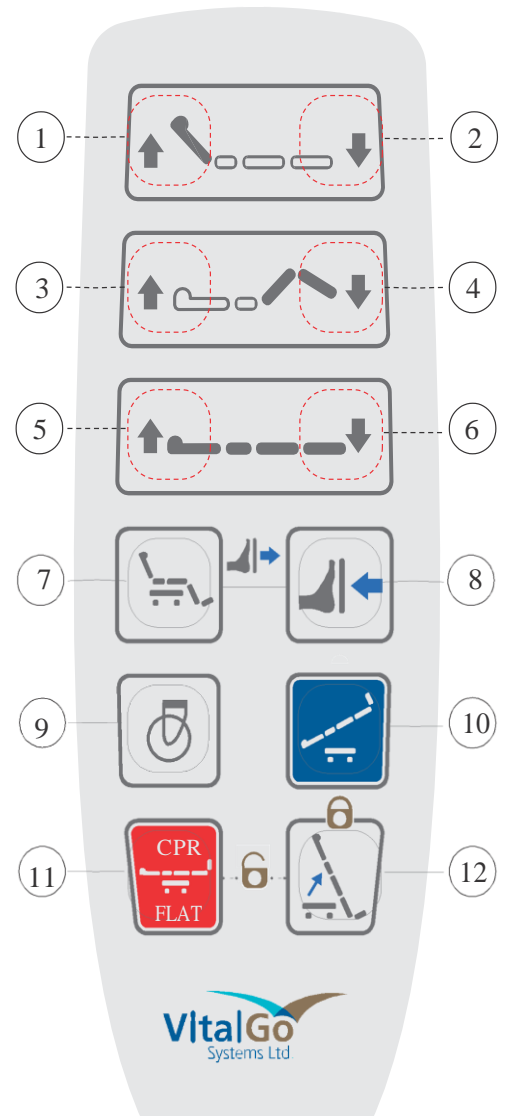

AUTOMATIC FUNCTIONS

- **SEATING WITH LEGS DOWN:**

Pressing Button (7) will bring the Bed to a pre-programmed seating with Legs Down.

A. Seating with Legs down will bring the center part of the Bed to a reclining position which gives the ultimate position in seating taking the Pelvis lower than the legs.

B. After the Leg rest will reach its lowest position the Foot-Lifter™ will move towards the feet and after touching the feet it will retreat a bit to avoid pressure on the feet and legs but yet giving a comfortable support to the feet.

C. If the Horizontal height of the bed is too low, the Bed will first be raised to the proper height to enable movement of the Leg-Rest down to the lowest possible position.

In case the position is not comfortable or needed to be adjusted, use buttons 1 to 4 for adjusting the Backrest and Leg rest. Also possible to move the foot lifter, as described above.

• **CPR – (SLEEPING POSITION) – BUTTON 11:**

The CPR brings the bed to a flat position with casters up. in a height of 20.67”(52.5cm).(Without Mattress), Pressing this function will bring the

Foot-Lifter™ to its center position or until the feet touches the foot lifter.

**Remark – When the bed is less than 20.67”(52.5cm), but not on casters, pressing button (11) will not move the bed. If the bed is on casters it will move the bed up, until casters are not in contact with the floor.*

Special Automatic Movements –

- A. The Bed will Automatically move all parts towards being in the above described Sleeping position.
- B. When reaching the end position of the function, two beeps will be heard as a confirmation.

**Remark– The user can use the manual functions to change its position, i.e. if he wants the Bed higher, the Back rest Upright or the Leg-rest and Foot Lifter™ in a different position.*

IMPORTANT NOTE

If the Bed is in an angle of above 20 degrees, the handset functions will not operate except for moving to standing or sleeping position with the Unlock Key.

NURSE FUNCTIONS: TILTING

The Tilting function should be used by the caregiver therefore those functions are locked.

In order to unlock the functions (12) press Button 11 and 12 Together for 3 seconds until a beep is heard.

The unlock will hold for 90 seconds after last press button 12.

After unlocking, press button 12 for tilting and button 11 to un-tilt.

When tilting the bed, a few parts of the bed will start moving, this is normal and the way it should work. The Foot-lifter will move towards the feet of the patient until it makes contact with the feet and only them the tilting will start. This avoids the patient from sliding down on the bed

• **TRENDERLENBURG POSITION –**

In order to reach the Trendelenburg position, press button (10).

This will automatically take the bed to a Trendelenburg position in an angle of 7.5 degrees.

In order to reach a higher angle, up to 12 degrees, press button 3 taking the leg-rest up. In order to move the bed to flat position, press the CPR Button (11).

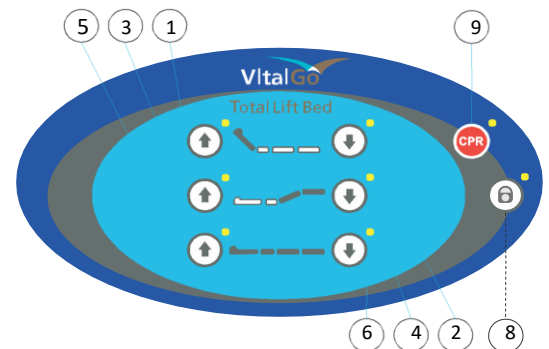
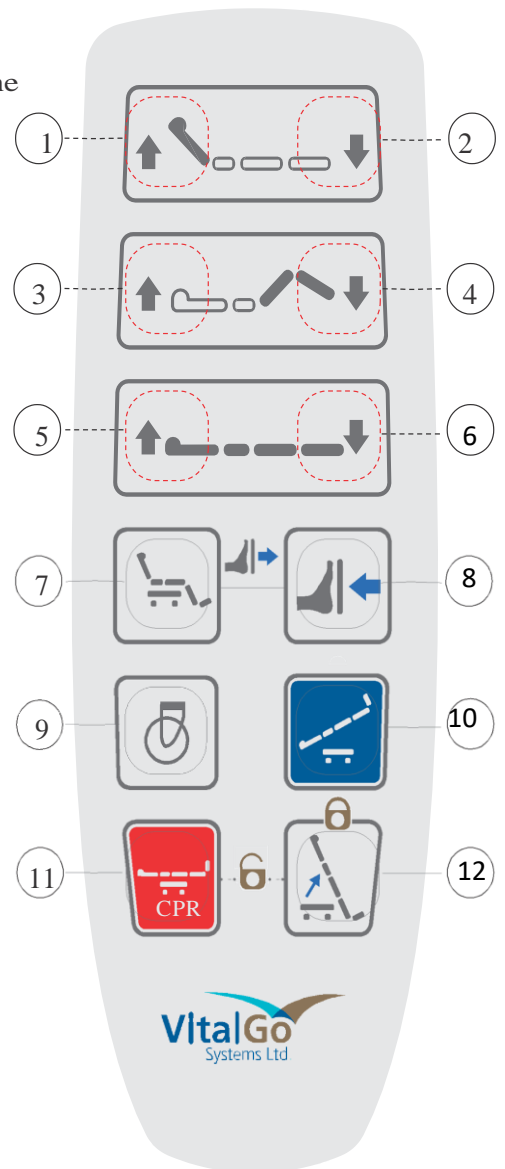

SIDE RAIL CONTROL PANEL OPERATION

Side Rail control panels are located on both sides of the two upper side rails.

The panels include all basic functions, but do not include the Tilting, Trendelenburg and auto seating functions.*

Locking the Panel - The panel facing the care-giver, includes a Lock button (button 8) – pressing this button for 3 seconds will lock all side rails operation, except for the CPR (will not affect the wired handset). When locked the symbol will illuminate in red.

Unlocking Panel – Press the Lock button (button 8) for 3 seconds, until the blue LED's on all operation buttons will illuminate.

When the panel is locked and any button is pressed, the lock symbol will illuminate in red, indicating that the panel is locked.

When panel is un-locked and one of the function buttons is pressed, all buttons will illuminate in blue.

Turning of Blue illumination - If buttons are not touched for 10 minutes, the illumination will shut off automatically.

* On the Side-Rail control Pressing buttons 8 (Lock) and 9 (CPR) together, will move the wheels down.

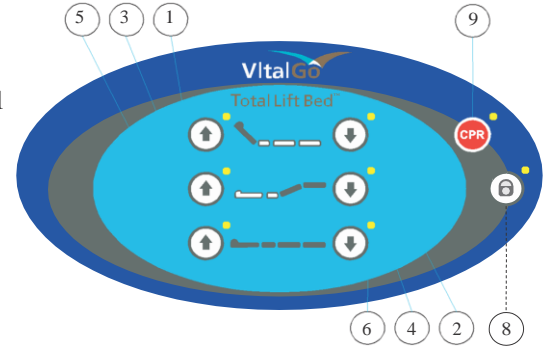

CLEARING ERRORS (Can be done by Care Giver)

The Total Lift Bed is operated with an advanced controller system.

It may happen that the controller will lose position of actuator and because of that, in order to avoid mechanical breakage, it will freeze.

In order to clear such error button 3+4 (on handset) or buttons 3+4 on Side-rail control panel, should be pressed together. A short series of 10 beeps will be heard. Wait until beeping stops. Try to operate bed. If bed does not operate make full initialization as described below.

In the event the “Clearing Error” does not help and the bed Backrest is up or the bed is in Tilt position, a “Safe Mode” operation may be performed in order to bring the Bed to a Flat (CPR) position (See below).

EMERGENCY SAFE MODE (In case the Bed “Freezes”) To manually lower the bed:

In the event that the Bed does not move at all when pressing the handset, or the side-rail LED lights are blinking, or the bed is beeping and not moving. First ensure that the bed is powered (check green signal on power supply). If power is on, this means that means that the bed is in Freeze mode. If this occurs when the bed is tilted or the head of the bed is elevated, use the *Safe Mode* to lower to flat position.

Step 1 – Hold buttons 5 + 6 (on handset) together for 5 seconds. The buzzer will give continues short signals indicating the Bed is in Safe Mode.

To tilt down, press 11 (on handset) (as you would normally) until the bed is flat.

To lower head of bed, press 2 (on handset) (as you would normally), until the head of the bed is flat.

Once the bed is flat or after 20 seconds without touching buttons 5+6, the Bed will exit Safe Mode

WARNING:

Although a Caregiver can perform the “Emergency safe mode”, any time it is used the bed should be inspected by a qualified technician before using the bed again.

Initialization of the Bed (Only by Technician)

Before first use, after replacing or disconnecting an actuator or controller, when placing the bed in place of operation, or in case of a functioning problem, the Bed must be initialized.

To Initialize (When initializing no one should be on the bed!):

Step 1 - Press Buttons 3+4 on Handset (or 3+4 on Side-rail control panel) together – 10 Continuous beeps will be heard. Continue pressing until the beeps stop.

Step 2 – Press Buttons 1+2 on Handset (or 1+2 on Side-rail control panel) together continuously. The bed will bring itself to the Initialization position step by step. Continue pressing until Two beeps are heard. To ensure the Bed has reached its initialization position, press again and verify the two beeps are heard.

Important remark: *In Initialization, the first movement of the bed should be horizontally up. If the bed does not move to its highest position something is wrong. Check all connections and redo steps 1 and 2. if the bed still does not work consult with VitalGo's authorized technician.*

At the end of the initialization procedure all motors should be in end of stroke position (in or out) –

- See Picture on page 12.

Step 3 – Bring the Bed to the Sleeping position with Button (11).

Emergency and Manual Tilt Lowering

In The event that the patient needs to be lowered quickly from the tilt position, or in case of a power or electric failure, follow instructions for manual emergency Quick Release lowering from Tilting position and bed position Reset.

1. Remove Safety Pin by pulling the CPR tag, At the lower head side of the bed. (Figure 1&2)



Figure 2



Figure 1

2. Pull the red lever (Figure 3, at top of bed under headboard pole) towards outside of the bed. Tilt frame will start moving down. Movement will stop when lever is released or support surface is horizontal.

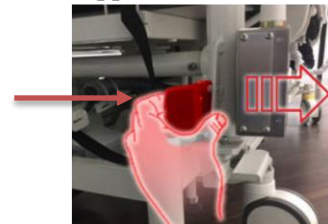

Figure 3

Ensure all persons and body parts are clear of the bed during manual lowering

Remark -

If the bed is in full tilt and does not begin to lower, gently pull the top of the support surface to initiate the movement.

After manually lowering bed function cannot be operated until the following steps are taken-

1. **Press and hold the wheel button (button #9)
Short beeps will be heard. Continue pressing
Until the wheels reach the floor
And the beeping stops.**
2. **Replace the CPR (for Tilt) Safety Pin with the red
CPR (for Tilt) Tag**

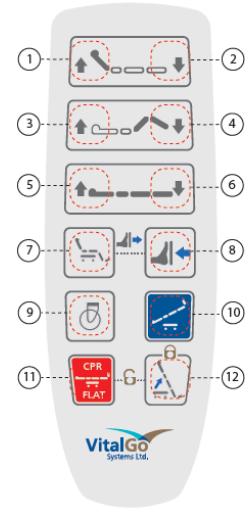

Bed can now be operated normally

Drainage Bag Holder/ Din Rails (Optional)

The Vitalgo TLB425T offers Drainage Bag Rail / Din Rail solution.
The Maximum weight that can be safely supported by each drainage bag and DIN rail is 11lb (5kg).
Items placed on the rails (such as patient urine bag) are included in the weighing safety load and can influence measurement of the patient weight when placed. (see weighing instruction on page 34)



Patient Strapping System

When Tilting a patient the Strapping System should be used with the supervision of the caregiver. The Strapping System is modular and should be used according to the patient's condition and instructions given by the proper authorized clinician. The Strapping system is comprised from 3 straps, as shown below.

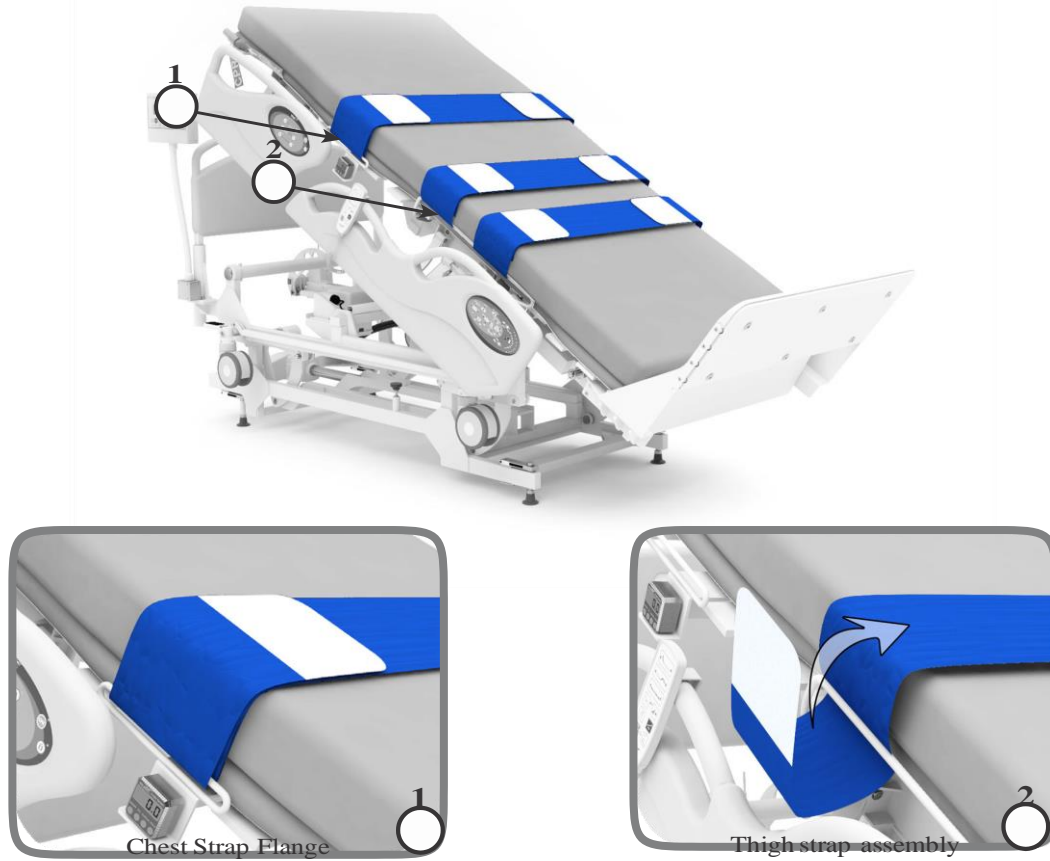

Retractable Head Board

The Head Board can be removed quickly by simply pulling it. It is especially designed for removal during CPR operations.

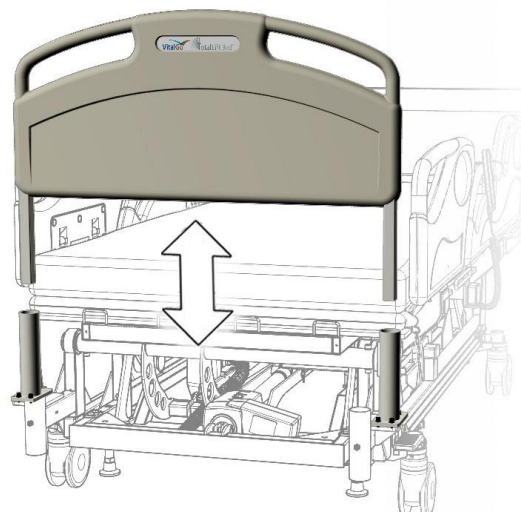

Mattress Attachment

The Mattress straps(1) are tied on the hooks at the two ends of the bed. There are four straps at each side, make sure that the mattress is attached firmly, to avoid movement of the mattress. The straps (2) should be attached on the support surface to prevent lateral movement. When attaching the mattress be aware to put the head and foot side in the right location.

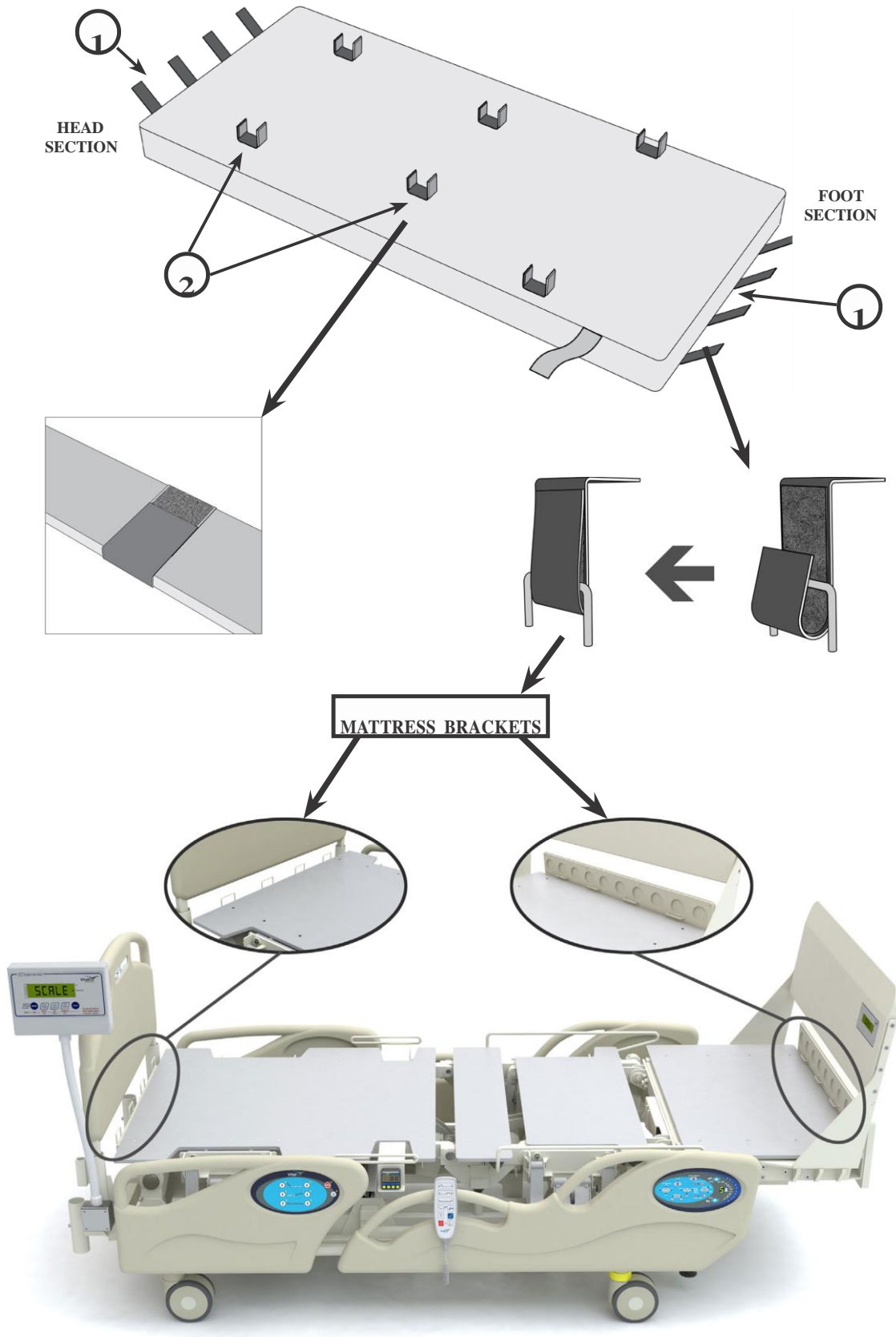

Troubleshooting

Problem	Possible Cause	Solution
Bed does not function at all	Power Cord not connected to Socket or to Controller Actuator plugs are not connected to controller Handset is not connected	Clear Error - See page 24 Check connection of both sides of Power cable. Check if Socket has electric power Check that all Actuator plugs are connected well in the controller socket. Check power supply is connected and has a green light Check handset connection to the controller. Check cable integrity If bed is tilted or backrest raised and CPR needed - use Manuel Mode - See page 24
Flashing Side-rails	Electrical Interference	Preform Clear error – see page 24
Hand set not functioning	Loose connection to Controller Program Failure	Clear Error - See page 24 Check connection of Handset wire to controller. Check that power cord is connected and see if the green light on the power supply is on. Call Technician
Bed movement is faulty	Program failure Plugs of Actuators are connected in the wrong socket of the controller.	Initialize Bed (Technician Only) Call Technician Do Not operate bed.
Bed movement does not stop	Continues pressing on Hand Set	Let go of switches
Bed is producing unusual sounds, burning odors or movement deviations observed in motors, bed parts or limits of hand switch/wired hand set functions	Electric or Mechanical Problem	Call Technician - don't move bed
Pressing a function hand set results in motion other than intended	Program failure Plugs of Actuators are connected in the wrong socket of the controller	Check all connections Initialize Bed (Technician Only) Call Technician and do not operate bed
Foot Lifter™ does not stop moving in reaction to resistance	Scale is off / Micro- switch failure (if no scale)	Call Technician - don't move bed
Bed continually beeping when handset is pressed (not 2 beeps)	Low power or no power	Check that power cord is connected
Bed does not move on wheels	Wheels are not down	Press wheel function till hearing two beeps.
Nurse Control failures: For standing position Bed does not move	The program was not unlocked	Check unlocking - see Nurse instructions

Maintenance



WARNING!

All repair and maintenance work should be performed only by a qualified technician. VitalGo will accept liability for the bed safety and functional efficiency only when:

- Delivery maintenance and repair were carried out by VitalGo's authorized personal.
- The bed is used in accordance to instructions given in the user's manual.

The Total-Lift Bed™ uses maintenance-free motors, electric systems and electronics; as such they require very little maintenance. All moving parts and lifting gear are permanently lubricated during manufacturing.

As these parts do not need to be re-lubricated in normal use, the bed has no lubrication points.

MAINTENANCE CHECKLIST

Vitalgo recommends the following maintenance and cleaning procedures be conducted between users and at least once every year.

- Inspect all bed components for damage or excessive wear.
- Visually examine all welds for cracks.
- Inspect the head and thigh and leg sections for bending, warping or damage.
- Check drive shaft and drive shaft connections for bending, damage or excessive wear.
- Inspect pull tubes and mounting hardware for bending, damage or excessive wear.
- Inspect all bolts and rivets to ensure that they are securely tightened and functioning properly.
- Check sleep surfaces to ensure all links are intact
- Check casters if they roll properly.

ELECTRICAL INSPECTION AND MAINTENANCE

- Inspect all electrical bed components for damage or excessive wear (i.e. Cracked or broken housings, or worn components).
- Check Hand pendant, power and motor cords for chafing, cuts or excessive wear.
- Make sure all plugs are fully attached and free of damage.
- Make sure cable lock on junction box is properly positioned and locked
- Check all functions:

A. Ensure head raises and lowers properly.

B. Ensure foot raises and lowers properly.

C. Ensure bed ends raise and lower properly.

If any of the inspection criteria Above mentioned failed, stop using the bed immediately, Tag the bed or component with a complete description of the failure(s) and have the bed serviced

RECHARGEABLE BATTERIES MAINTENANCE:

BA20 is the battery module in the CB20 system. The cabinet is ultrasonic welded and easily exchangeable without the use of tools.

Precautions:

Battery running:

- If battery capacity is under 50% a “beep” sound is given for 2 seconds, when a handset key is pressed.
-
-
- The CB20 with battery back-up only commences battery charging when it is connected to the mains.
- A control box with battery should be charged at least every six months. However the longest life is obtained when the battery is fully charged.
- A battery must be charged for at least 12 hours before use

Cleaning and Disinfecting (For regular use and reapplication use of Bed by same user):

Cleaning the bed is important for proper disinfection.

In case the same person is using the bed, a routine cleaning of the Bed is hygienically sufficient.

Disinfection of the Bed is necessary in case of contamination with infectious or potentially infectious material, as blood, stool, pus or presence of infectious disease under the direction of a physician.

In Case of a Patient change (Reapplication):

If a new patient/user is introduced to the bed, the Bed must be first cleaned washed and disinfected.

Before cleaning please note –

- All electric plugs and covers connected to the controller must be plugged in.
- Power cable must be unplugged from wall socket and protected from liquid.

Cleaning:

Remove mattress from Bed, raise back support and legs sections, so all parts are accessible.

The metal parts of the Bed are covered with a powder coating. Clean all coated parts with mild detergent and warm water.

The plastic parts may be cleaned with a fresh wet cloth with warm water and household cleaners.

Disinfecting:

The disinfectant material used should be an approved material by DGHM (German Association for Hygiene and Microbiology).

The Thinning ratio recommended in the respective instructions must be applied.

Follow the manufacturer guidelines for exact dosage and way of use.

Do not use:

- Solvents (Including organic solvents)
- Abrasive or scrubbing sponges, which might scratch the Beds surface and materials.

If unsuitable washing powder or disinfectants are used in incorrect mixing ratio, or in case of insufficient maintenance, there might occur damage to surface of coating of bed, for which the company will not be responsible for.

When using disinfectants, always:

- Wear gloves.
- Avoid skin contact.
- Use closeable bottles with dosage pumps.
- Use a clean towel.
- Do not store the mixed disinfectant in pen containers with the cleaning rag inside.
- Ventilate room after finishing disinfection.

Total Lift Bed – Weight Bearing Control System

Vitalgo's Total Lift Bed brings the first and only true "Weight Bearing Control" ever.

The combination weighing systems comprises a Bed Scale and Foot-Lifter Scale.

The display connected to the gooseneck is displaying three measurements –

1. The Patient weight.
2. The pressure applied on the Foot-Lifter.
3. The percentage of the Pressure on the foot –lifter as a ratio to the Patient weight.

As the patient is tilted or taken down, due to gravity the amount of pressure the patient is bearing becomes greater or lesser. This is showed by the percentage indicator.

NOTE: In the EU countries the scale is a class III. Accuracy and calibration date information, can be found on the front and back of the scale display respectively

OPERATION –

IMPORTANT – Scale must be on when bed is in operation, otherwise bed will not function well.

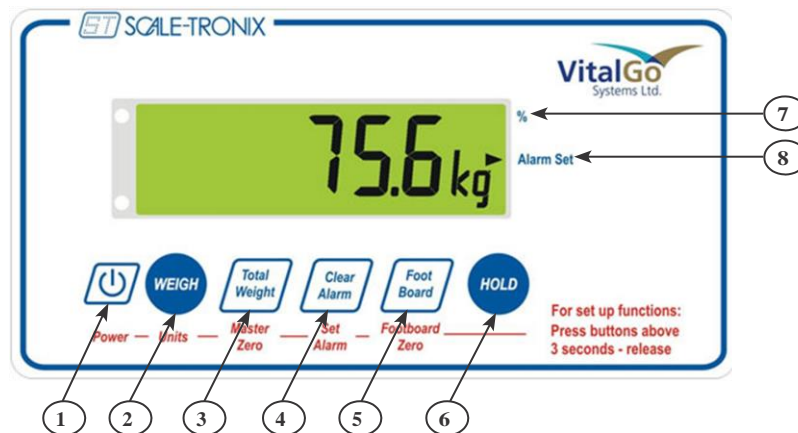

a. For patient weight –

1. Place bed on its legs (load Cells) and be sure the bed is not on casters.
2. If display is not on, press button "1" to start scale operation.
3. Bring Bed to horizontal position, check that required bedding is on the bed, but patient is not on the bed.
4. Master Zero – Press and hold button "3" for 4 seconds and release after hearing two beeps.
Important Note – Do Not activate master Zero – button "3" when patient is in bed.
5. Scale will read 0.0 (Zero) – patient can enter bed.
6. The weight of the patient will be displayed after a few seconds.
7. After scale is not active for 10 minutes it will display "SCALE". To show weight again, press "Weigh" Button "2" or "Hold" button "6".
8. Kg/lb – to switch between kg/lb press button "2" "weigh" for 3 seconds. (not applicable on EU version)

B. Adding / Removing bedding / items to Bed –

1. Press "HOLD" button "6".
2. Add items to bed.
3. Press "WEIGH" button 2 and the weighing feature will resume, not changing the patient weight reading.
4. To remove items from Bed, follow same procedure.

C. Foot Lifter Scale –

Foot-Lifter scale reading can be seen in two displays, the display on the Foot-lifter and the main display. The Foot-lifter Display will always show the amount of pressure placed on the Foot-Lifter.

For the main display –

1. Press “Foot Board” button “5”. The pressure on the Foot-Lifter will be displayed.
2. Press second time for the Percentage between the pressure on the foot-lifter and the patient weight. The arrow on % (“7” on the display) will show.
3. For “ZERO” the Foot-Lifter scale –
 - Press “Foot Board” button “5”.
 - Press Button “5” again for 4 seconds.

IMPORTANT – Always “ZERO” when bed is in horizontal position.

NOTES –

- The Foot-Lifter scale is not for measuring the patient weight.
- There is an increase of 16-18 Lb (7-8 kg) to the reading of the scale between Horizontal position and Standing position. This is due to the gravity of the Footboard itself.
- The Foot-Lifter scale is operating with other functions of the bed, so should always be “On”.

D. Weigh Bearing -

WEIGH BEARING IS THE PERCENTAGE BETWEEN THE PRESSURE APPLIED BY THE PATIENT FEET ON THE FOOT-LIFTER AND HIS WEIGHT.

1. When the display is showing the patient weight, press “foot-Board” button “5” – the main display will show the amount of pressure on the foot-board.
2. Press again button “Foot-Board” button “5” – the display will show the percentage between the pressure on the Foot-Board and the patient weight. The arrow on the % on the top right side of the display will show “7”.
3. For going back to patient weight press “Total weigh” (short press) Button “3”.

E. Alarm Feature –

1. Hold Button “4” Clear / Set Alarm for 3 seconds until two beeps are heard.
2. The arrow “Alarm Set “8” will show. Alarm is now armed.
3. If patient exits bed (or items removed from bed) the Buzzer will go on.

NOTE – If scale is in “HOLD” mode too long (see “B” above), the Buzzer will go on as well and the display will be flashing ”HOLD”.

TO SHUT ALARM – press “Clear Alarm” Button “4” (quick press) or “WEIGH” button “2” if in the “HOLD” mode

F. Unit Change – (not applicable on EU beds)

Press button “2” “WEIGH” for 3 seconds – Units will change between Lb/Kg in both displays, main and Foot-Board display.

Use of the “Weight Bearing Control” system is used for many important applications in which it is important to know the amount of pressure the patient can bear on his feet.

The system is also important for –

- Prevention and care of Pressure ulcers.
- Early Mobility.
- Progressive Mobility/
- Physical Therapy.
- Burn units.

















Low Air Loss Mattress System

THE TLB425 HAS AN INTEGRAL LAL MATTRESS SYSTEM, HAVING THE PUMP CONNECTED TO THE FRAME OF THE BED AND THE CONTROL UNIT (A) TO THE RIGHT FOOT END SIDE-RAIL.

The VG-TLB425-MAT-CAM4-System is a 5-zone ALTERNATING PRESSURE & TRUE LOW AIR LOSS control. The system comes with a one of a kind built-in pump(Q). The control unit is designed to provide continuous ALTERNATING PRESSURE & TRUE LOW AIR LOSS pressure at required patient comfort levels.

The mattress replacement system (B) is comprised of a durable Cordura base (C) with a safety 1” convoluted foam, and 5” (inflated) detachable air cushions (T), and covered with a vapor permeable, water proof, low friction and low shear nylon quilted top sheet (E) with zipper to fasten the top sheet to the mattress base.

EXPLANATION OF SYMBOLS USED ON THIS DEVICE

SYMBOL	EXPLANATION
 POWER	Turns unit On / Off
 SOFT	Up or Down key adjusts patient comfort pressures levels
 FIRM	
 MODE	Selects appropriate t interval mode
 MAX FLOW	Inflates mattress rapidly (30 minute timer)
 FOWLER/ TILTING	Boosts 15~25 % more air pressures in the mattress during fowler/Tilting position to avoid patient bottoming out
 LOCK	Locks out all control unit functions to prevent patient settings tampering
 POWER FAIL	In the event of power failure or if the hose is disconnected an audio/visual alarm will sound
 LOW PRESSURE	
 ALARM SILENCE	Mutes audio alarm
	Attention: Instructs end user / care giver / operator to refer to the manual.
	Indicates that the degree of protection against electrical shock is TYPE BF
	Not for use in presence of flammable anesthetics.
	Risk of electrical shock, do not remove back cover.
	Sets alternating pressure therapy times, 5,10,15,20 minutes.
	for static and alternating

MAIN FEATURES OF THE VG-TLB425T-MAT-

- Medium Flow (42-52 LPM) Air Output with quiet operating control unit. Max Flow mode (W) inflates mattress in 5 to 10 minutes, has 30 minute max flow timer.
- State of the art micro-controller technology unit for accurate patient comfort pressure values and A/P time.
- Front panel (A) has power switch (PS), and desired comfort pressure level.
- Comfort control keys (K) to set comfort levels, according to weight of the user.
- Therapy (Static) mode LED (MD).
- A/P (alternating Pressure) mode LED (N).
- Lock Switch (LO) to lock out all control functions.
- Durable and attractive dual 3/4" and one 1/4" flow couplings
- (R) for quick connection and disconnection (CPR deflation). See below – CPR Figure.
- Control unit has short circuit / over voltage protection with single/dual fuse (S) not shown in the picture.
- Power Fail (PF) LED flashes to indicate power outage.
- Low Pressure (LP) LED flashes to indicate low pressure.

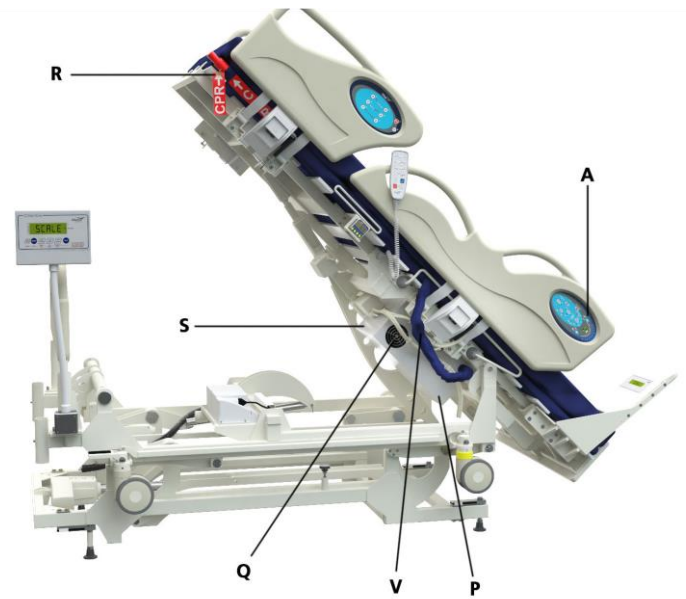

SUPPORT SURFACE (MATTRESS / OVERLAY)

- Detachable urethane coated 70 Denier nylon taffeta, flame retardant / water repellent, mildew resistant, low friction and low shear air cushions.
- 5" high (inflated) and 4.4" high detachable lateral tubular air cushions (T) convoluted safety foam enclosed in the base (C) to support the patient in the event of loss of air pressure in the mattress.
- Total height of support mattress 7" and 5.5" at leg area.
- Detachable zippered or strapped highly breathable urethane coated, 70 Denier nylon, flame retardant / water repellent, highly vapor permeable, anti-microbial, low friction and low shear quilted reusable top sheet (E).
- The mattress has hose assembly (V) with two easy to use quick connect and disconnect connectors.

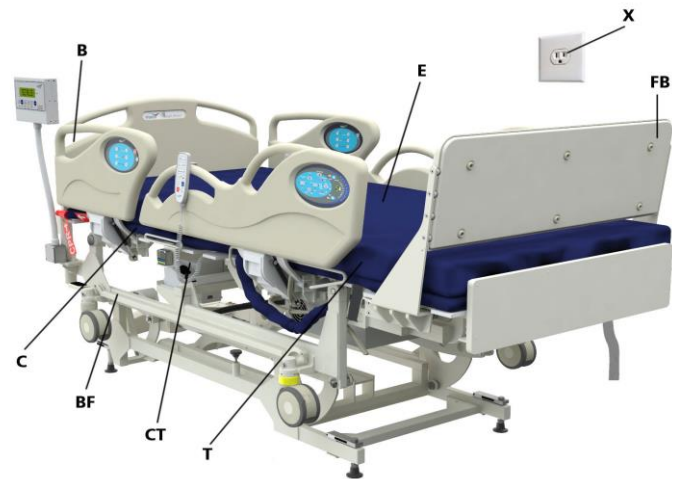

Operating Instructions

INITIAL POWER UP

Make sure the mattress hose assembly (V) connected securely during initial power up (when power cord is plugged into the power source), the control unit (A) will be in “STAND BY” with the amber LED on.

If the unit is in standby mode with amber LED is on, press  the power key and the green LED will turn on.

Press MAX FLOW (W) the pump will turn on at maximum flow.

If the power comes on after a power outage, the control unit will go through its system initialization routine for few seconds and then resume the desired function.

MAX FLOW (W)

Press  MAX FLOW (W) key, the green LED will turn on. This mode is used to rapidly inflate the mattress. During this mode a series of beeps will sound every 3 minutes as a reminder that MAX FLOW mode has been activated.

MAX FLOW mode will deactivate after 30 minutes. The LED will turn off and the unit will default to previous memory setting. During this mode the entire mattress will be pressurized to 35±6 mmHg.

THERAPY (STATIC) (M)

- To set STATIC mode (M) press  (MD) key to “STATIC” position, a green LED (M) lights up.
- In STATIC mode all the air cushions in the mattress will be maintained at a constant pressure. , according to the set pressure(CP).

DYNAMIC (A/P) ALTERNATING PRESSURE (N)

To set DYNAMIC (ALTERNATING) {N} mode, press the mode  (MD) key and choose the appropriate A/P time. The green LED (N) lights up. The A/P cycle times are 5, 10, 15, 20 minutes.

In the A/P (DYNAMIC) mode the odd numbered air cushions in the mattress will be maintain at a constant desired patient comfort pressure, and the even numbered air cushions will deflate from desired patient comfort pressure to below 10~60% of set pressure in the first half of the DYNAMIC cycle and vice versa for the second half of the cycle, and continue back and forth.

PATIENT COMFORT CONTROL LEVEL (K)

- The VG-TLB425-CAM4 system is designed for patients weighting between 50 to 425 lbs. (23Kg. 193Kg.). Pressing the comfort control  SOFT key (K) towards the SOFT (1) position reduces the

pressure setting, pressing  FIRM key (K) towards the FIRM (9) position increases the pressure. The patient comfort pressure ranges from SOFT (1) 6±4 mmHg to FIRM 32 ± 6 mmHg. Depending on the desired patient comfort level(CP) the micro-controller / sensors will set appropriate air pressure in the mattress, and maintain the desired pressure in the mattress.

- Once the mattress is inflated to its normal size with the patient lying on it, set the COMFORT CONTROL KEY to the desired patient comfort level. Wait 5 minutes for the mattress pressure to stabilize, verify the appropriate pressure required to support the patient by performing a simple “four finger check”.

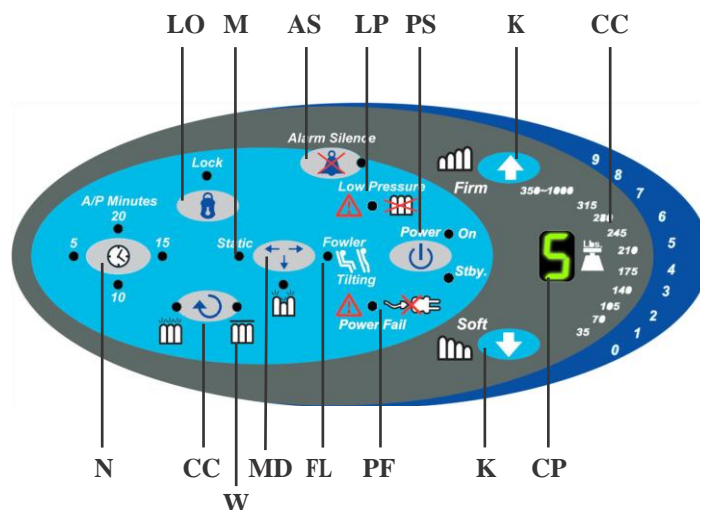

Make sure that the patient is lying flat on his or her back in the middle of the mattress. Place four fingers between the air cushions directly underneath the sacral region of the patient’s body. There should be a minimum of 3 to 4 finger width clearance between the bottom of the patient and the safety foam base, Repeat this procedure until the desired patient comfort pressure is achieved.

UPRIGHT (U)

When tilt or upright  (fowler) mode is chosen, the pressures in the entire mattress will be increased to max comfort setting (Optional: approximately 15 ~ 25 % higher than the set comfort pressure level or max 9 level). This enables the patient to be supported without bottoming out.

LOCK OUT (LO)

Control unit functions (including power) can be completely locked out from being tampered with, by simply pressing and holding the  lock key until the light comes on (approximately 3 seconds).

ALARM SILENCE (AS)

An audio-visual alarm is sounded in the event of power failure or when the hose is disconnected from the unit. Audio alarm can be muted by pressing  alarm silence key.

FAILURE MODES

POWER FAIL (PF)

3. In the event of power outage the microprocessor will activate an audiovisual signal to alert the caregiver by flashing the amber “POWER FAIL” LED and turning on the buzzer. Once the power is restored to the control unit the audiovisual signal will cease and unit resumes operating its set mode.

LOW PRESSURE (LP)

In the event of hose disconnection the microprocessor will activate an audiovisual signal to alert the caregiver by flashing the amber “LOW PRESSURE” LED and turning on the buzzer. Once the low pressure problem is fixed the audiovisual signal will cease and the unit resumes operating its set mode.

RECOMMENDED PRESSURE SETTINGS

- a. For rapid inflation of the mattress press (W) “MAX FLOW” key until green LED turns on.
- b. For extra firm support during Patient ingress/ egress, or Patient wound care, or Patient turning, or Patient cleaning it is recommended to set the mattress pressure to MAX by pressing (W) “MAX FLOW” key.
- c. During patient Fowler positioning, or in case of a patient who’s weight to height ratio is above average, it is recommended to set the comfort control to 10% more than the set pressure level.

CPR FUNCTION

To deflate the mattress / overlay pad or for a CPR procedure, press the quick release buttons on both the coupling bodies (V), and simultaneously rotate the red CPR valve (R) to the “OPEN” position, see figure 2.

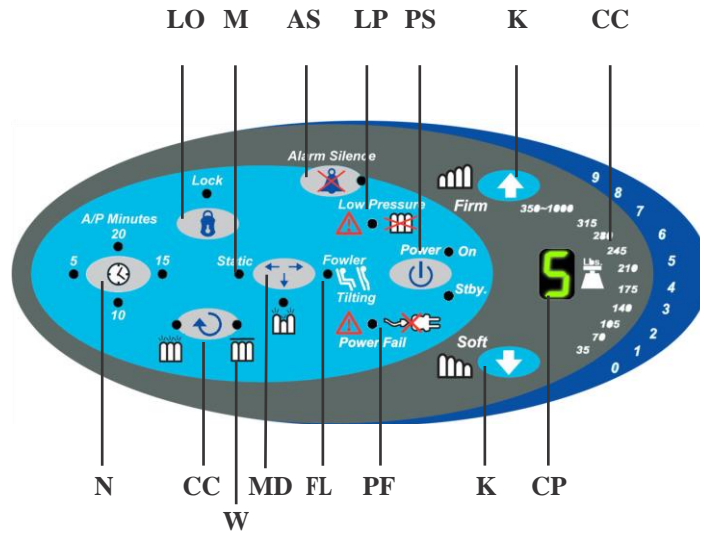

CPR FUNCTION
(VG-TLB425-CAM4 mattress systems)



FIGURE 1



FIGURE 2

FIGURE CPR: MATTRESS WITH CPR VALVE

1. When inflating mattress, rotate the red CPR valve to the “CLOSE” position, see figure 1.
2. To deflate the mattress, rotate the red CPR valve to the “OPEN” position, see figure 2.

TECHNICAL SPECIFICATIONS

ELECTRICAL SPECIFICATIONS

	<u>U.S.</u>	<u>INTL.</u>
Input Voltage AC:	120V	220V / 240V
Input Frequency:	60 Hz	50 Hz
Current:	1A	0.5 A
Maximum Power Consumption:	40 ± 5 W	40 ± 5 W
Circuit Protection:	Single/dual fused, 250V, 1A fast blow fuses(S)	
Mode of Operation:	Continuous	Continuous

PERFORMANCE SPECIFICATIONS

WEIGHT CAPACITY:

425 Lb. (193 Kg.) maximum.

	<u>U.S. / INTL.</u>
Pressure Zone:	2
Max Flow:	42~52 LPM
Max Flow Pressure:	35±6 mmHg
Max Flow Timer:	30 minutes
Support Surface Inflation Time:	5~10 minutes.

PATIENT COMFORT CONTROL PRESSURES

Soft Pressure:	6 ± 4 mmHg Firm
Pressure:	32 ± 6 mmHg Cycle Time:
5,10,15,20 Min	

PATIENT CONTACT:

Control unit and mattress have **lead-free, mercury-free and latex-Free** components.

MECHANICAL SPECIFICATIONS

SUPPORT SURFACE

AIR CUSHIONS: 70 denier urethane-coated nylon, R.F. welded, liquid proof and washable. Cal.117 pass.

BASE: 1000 denier cordura, liquid proof and washable. Cal.117 pass.

TOP SHEET: 70 denier urethane-coated nylon, low friction, low shear force producing, breathable, liquid resistant and highly vapor permeable. Cal.117 pass.

Low Air Loss Top Sheet has 3 layers; top layer is breathable nylon, middle layer is an air distribution spacer material, and the bottom layer is a water resistant nylon layer.

<u>Description</u>	<u>Inflated Dim. LxWxH</u>	<u>Weight</u>
Mattress:	78.5”x36”x7” (199x91.4x17.8)	18lb. 8.2Kg.
Compressor :		14lb.(6.4kg)

ENVIRONMENTAL SPECIFICATIONS

OPERATING CONDITIONS:

Ambient Temperature: 40° ~ 104° F
 10° ~ 40° C
 Relative Humidity: 30% ~ 75% Non-Condensing
 Atmospheric Pressure: 700 hPa to 1060 hPa

STORAGE AND SHIPPING CONDITIONS:

Ambient Temperature: -40° ~ 158° F
 -40° ~ 70° C Relative
 Humidity: 10% ~ 100% Atmospheric
 Pressure: 500 hPa to 1060 hPa

PROTECTION AGAINST HARMFUL INGRESS OF LIQUIDS:

Ordinary Protection (IPX0)

MATTRESS SANITATION:

Complete support surface is made of superior quality materials and is modular in construction. All components such as manifold, hose assembly, air cushions, top sheet, and foam base are interchangeable and can be easily cleaned or detached for laundry.

SAFETY AGENCY APPROVALS



The standard for safety of Medical Electrical Equipment

Conforms To: UL STD 60601-1 with respect to
 Electrical Shock, Fire and Mechanical Hazards

Certified To: CAN/CSA STD C22.2 No. 601.1

CE Mark: 

FLAME RESISTANCE: Unit components meet UL 94V-0.
 Mattress components pass California 117.

TLB Total Drive System (TDS) Instructions for use (Optional)

Device Overview

The Total Lift Bed is designed to treat up to 425lb (193kg) patients and must be stable doing so. The large platform it uses to keep it stable and safe causes it to be heavier to move. For helping to move the TLB425T VitalGo has developed a unique patent pending, user friendly Total- Drive™ System.



WARNING: Instructions below are very important and should be read carefully in order to use and enjoy the benefits of the TDS.

General Operation:

The Total Drive System™ is connected on the same frame of the 4 regular casters. As a result, there is no need moving the Total Drive up & down for making contact with the floor. The TDS can be used when ever casters are down.

Due to its special design, the TDS can move to any direction 360 degrees. When not using the power of the drive, the bed can move sidewise with no difficulty, by just pushing the bed to the side, as done regularly.

For safety reasons, the power will not operate when the bed is connected to main power. So in order to operate the drive, the power must be taken out from the power outlet.

The TDS is operating with its own chargeable batteries, when charged, having enough power for driving the bed for a few Miles/Km.

For charging the batteries, just connect the bed to power.

Buttonology and Function

Throttle (Speed adjusted by pressure)

Forward / Reverse Movement



LED Lights (Battery Charge Indicator)

Power Button (TDS on/off)

Power Button: When pressing the Power Button the TDS will go “On” or “Off”. When going “On” from “Off” position, all light indications will briefly go on.

For moving the bed without power, power button should be OFF

Battery Charge Indicator:

- Green Led lights lit, indicates well-charged Batteries.
- Amber or Red Led lights lit, indicates batteries are moderately charged.
(Note that whenever the bed is connected to power, the TDS batteries are charging).
- If only Red Led lights are lit, Batteries need to be charged before use. To charge, just plug the bed into a wall outlet as in normal use.

Forward / Reverse: By pressing this button it will switch movement from forward to backwards movement and vice versa. **When the Reverse mode is engaged there will be long beeps heard to indicate. Press the button to return to Forward mode.**



*It is recommended to make a small movement, pressing the throttle slightly, in order to be sure of the direction the bed will move, forwards or backwards.
Before trying to operate the TDS the bed power must be disconnected from the power wall socket, otherwise the TDS will not function.*

Throttle: When pressing the throttle, the bed will start moving. The more it is pressed the speed will increase to maximum of 2.5 mph (4kmh), when batteries are fully charged and on a flat surface.

TDS Braking Systems

The TDS has an automatic braking system. If the throttle is released the automatic break will engage and bed will slow down.

TDS Brake Disengage

In order to put the TDS system in Neutral to move the bed manually, the TDS Power button should be OFF.



CAUTION: The TDS should always be Off when not in use by a health care professional.

Steps for transporting the bed



WARNING: Maximum patient weight in bed for transport is 425 lbs. (193 kg). Transporting a patient above 425lbs can damage the bed and/or cause injury.

1. Ensure side rails are latched in an upright position.
2. Press the wheel/caster button (button 11) on the bed handset to bring all casters down to the floor (until two beeps are heard to signal the tilt frame is all the way up).
3. Unplug the bed AC power cord, wrap the AC power cord around the headboard.
4. Press the On/Off Button of the power drive controller, bringing the TDS to on position (Lights should come on).

- 5 . Select the desired direction (forward or reverse).
- 6 . Push the Throttle lever forward slowly to make sure the desired direction is correct.
- 7 . Apply throttle pressure according to the desired speed.



WARNING: Side rails must be in the highest position to prevent patient from falling out of bed



WARNING: Moving bed down inclines or excursion off a ledge (such as moving into an elevator or across a threshold) can result in damage to the bed and injury to persons.



CAUTION: The drive system is intended to move the TLB425T on flat level surfaces. If necessary, the drive system can transition and climb up to a 5 degree incline with a patient. Extra care should be taken when transitioning at the bottom and top of ramps. Loss of traction at the drive wheels



CAUTION: Check the bed width and side rail adjustment for doorway clearance to prevent damage to the bed and door frames.



CAUTION: Keep hands and feet clear of wheels during bed movement. Move the bed only at a slow walk.

NOTE: Remember to plug the Powercord bed into the wall outlet once transport of the bed is complete.

After Transport is completed

1. Press the On/Off button to Off position (No LED lights)
2. Press CPR or other function on the bed handset or side rail to bring casters up, so no contact of casters with the floor, or lock the casters by pressing the caster lock mechanism on the side of the bed frame.
3. Plug bed back into wall outlet to charge if possible.

CHARGING THE DRIVE SYSTEM BATTERIES

Charging the batteries is the most important part of operating and maintaining the Drive System. Be sure to do it properly!



WARNING: Only batteries provided by VitalGo should be used. Never use regular car starter batteries. To avoid risk of serious chemical burns and damage of the equipment do not use flooded cell lead-acid batteries.

NOTE: The battery charger provided is specially designed for use with VitalGo TLB425T equipment. In the unlikely event of failure, it should be replaced only with a VitalGo approved charger to assure proper performance of the charger and Drive System.

Basic Safety Instructions

- Do not expose the charger to rain, snow or other moisture sources (i.e., sprinkler, car wash, etc). When storing bed, keep indoors.
- Use of the charger in a manner not recommended by the manufacturer may result in the risk of fire, electrical shock or personal injury.
- To reduce the possibility of damage to the AC cord or the connector, disconnect the AC line cord by grasping the plug and not the cord, when disconnecting from the wall or receptacle.
- Locate cord so that it will not be stepped on, tripped over or subjected to the possibility of damage.
- An extension cord is not recommended for use with this equipment. Use of an improperly rated extension cord could result in risk of fire or electrical shock. Should it be required to use an extension cord, make certain that it is of 3-wire construction and has a wire size of 16-gauge, and the cord must be in good electrical condition.
- Do not operate this charger with damaged AC cord or receptacle. If they are damaged, replace them immediately.

Total Drive System Specs

Mechanical

Battery	1 x 24V 16AH Lithium Battery
Speed: Adjustable	2.5 mph / 4.00 kph
Range:	5-7 miles / 8-11.27 km (Varies with weight)
Turning Radius:	50" / 127 cm
Maximum Obstacle Climbing Height:	1.5" / 3.8cm (With Run-Up) Maximum
Incline Climbing Slope:	5 Degrees upward or downward
Maximum weight capacity:	425 lbs. (193 Kg.)

Electrical

Input voltage:	100 - 240 Vac – 50/60 HZ
Amps	2.0A
Charger Output voltage:	DC 24V / 2.0A

Digital Inclinometer – Angle Sensor (optional)



The Inclinometer (angle Sensor) is used to show the angle between the floor and the fowler position, which can be the angle of the Backrest or the Tilting of the bed.

OPERATION –

Press On/Off – Button “1” and the angle will be displayed.

The reading shuts off automatically after a while to save battery.

NOTE – the Inclinometer is calibrated and there is no need to use all other buttons which are for checking comparative angles.

USE OF INCLINOMETER –

The Inclinometer is very important for collecting data concerning the patient position in the bed and for the treatment he is getting in order to check the change of the patient condition and to follow the protocol of treatment.

Declaration of Electromagnetic Environment guidelines.

Declaration – electromagnetic emissions		
Emissions test	Compliance	Electromagnetic environment – guidance
RF emissions CISPR 11	Group1 Class A	The VG-TLB 425T uses RF energy only for its internal function. Therefore, its RF emissions are very low and are not likely to cause any interference in nearby electronic equipment.
Harmonic emissions IEC 61000-3-2	Class A	The VG-TLB 425T is suitable for use in all establishments other than domestic, and may be used in domestic establishments and those directly connected to the public low-voltage power supply network that supplies buildings used for domestic purposes, provided the following warning is heeded: Warning: This equipment/system is intended for use by healthcare professionals only. This equipment/ system may cause radio interference or may disrupt the operation of nearby equipment. It may be necessary to take mitigation measures, such as re-orienting or relocating the VG-TLB 425T or shielding the location.
Voltage Fluctuations And Flicker IEC 61000-3-3:2013	Complies	

Declaration – electromagnetic immunity			
IMMUNITY test	IEC 60601 test level	Compliance level	Electromagnetic environment – guidance
Electrostatic discharge (ESD) IEC 61000-4-2	8 kV contact 2, 4, 8, 15kV air	8 kV contact 2, 4, 8, 15kV air	Floors should be wood, concrete or ceramic tile. If floors are covered with synthetic material, the relative humidity should be at least 30 %.
Electrical fast transient/burst IEC 61000-4-4	2 kV for power supply lines 1 kV for input/output lines	2 kV for power supply lines N/A	Mains power quality should be that of a typical commercial or hospital environment.
Surge IEC 61000-4-5	1 kV line(s) to line(s) 2 kV line(s) to earth 2 kV Signal input/output) to earth	1 kV line(s) to line(s) 2 kV line(s) to earth N/A	Mains power quality should be that of a typical commercial or hospital environment.
Voltage dips, short interruptions and voltage variations on power supply input lines IEC 61000-4-11	0% UT; 0.5cycle at 0°, 45°, 90°, 135°,180°, 225°, 270° and 315° 0% UT; 1cycle and 70% UT; 25/30 cycles Single phase at 0° 0% UT; 250/300 cycle	0% UT; 0.5cycle at 0°, 45°, 90°, 135°,180°, 225°, 270° and 315° 0% UT; 1cycle and 70% UT; 25/30 cycles	Mains power quality should be that of a typical commercial or hospital environment. If the user of the VG-TLB 425T requires continued operation during power mains interruptions, it is recommended that the VG-TLB 425T be powered from an

		Single phase at 0° 0% UT; 250/300 cycle	uninterruptible power supply or a battery.
Power frequency (50/60 Hz) magnetic field IEC 61000-4-8	30 (A/m)	30 (A/m)	Power frequency magnetic fields should be at levels characteristic of a typical location in a typical commercial or hospital environment.
NOTE UT is the a.c. mains voltage prior to application of the test level.			

Declaration – electromagnetic immunity			
IMMUNITY test	IEC 60601 TEST LEVEL	Compliance level	Electromagnetic environment – guidance
Conducted RF IEC 61000-4-6	3V, 6V	3Vrms, 6V	<p>Portable and mobile RF communications equipment should be used no closer to any part of the VG-TLB 425T, including cables, than the recommended separation distance calculated from the equation applicable to the frequency of the transmitter.</p> <p>Recommended separation distance</p> $d = \left[\frac{3,5}{V_1} \right] \sqrt{P}$ $d = \left[\frac{12}{V_2} \right] \sqrt{P}$ $d = \left[\frac{12}{E_1} \right] \sqrt{P} \quad 80 \text{ MHz to } 800 \text{ MHz}$ $d = \left[\frac{23}{E_1} \right] \sqrt{P} \quad 800 \text{ MHz to } 2,5 \text{ GHz}$ <p>where P is the maximum output power rating of the transmitter in watts (W) according to the transmitter manufacturer and d is the recommended separation distance in metres (m).</p> <p>Field strengths from fixed RF transmitters, as determined by an electromagnetic site survey, should be less than the compliance level in each frequency range.</p> <p>D Interference may occur in the vicinity of equipment marked with the following symbol:</p> 
Radiated RF IEC 61000-4-3	N/A	N/A Large medical equipment are exempt from standard procedure	

Recommended separation distances between portable and mobile RF communications equipment and the VG-TLB 425T				
Rated maximum output power of transmitter W	Separation distance according to frequency of transmitter m			
	150 kHz to 80 MHz outside ISM bands $d = \left[\frac{3,5}{V_1}\right]\sqrt{P}$	150 kHz to 80 MHz in ISM bands $d = \left[\frac{12}{V_2}\right]\sqrt{P}$	80 MHz to 800 MHz $d = \left[\frac{12}{E_1}\right]\sqrt{P}$	800 MHz to 2,5 GHz $d = \left[\frac{23}{E_1}\right]\sqrt{P}$
0.01	0.12	0.2	0.4	1
0.1	0.37	0.64	1.3	2.6
1	1.17	2	4	8
10	3.7	6.4	13	26
100	11.7	20	40	80

LIMITED WARRANTY

This warranty is extended only to the original purchaser who purchases this product when new and unused from Vitalgo or a dealer. This warranty is not extended to any other person or entity and is not transferable or assignable to any subsequent purchaser or owner.

Coverage -

The coverage under this warranty will end upon any such subsequent sale or other transfer of title to any other person.

Vitalgo warrants the mechanical and electrical components of this product when purchased new and unused to be free from defects in materials and workmanship for a period of one year from date of purchase from Vitalgo or a dealer, with a copy of the seller's invoice required for coverage under this warranty.

If within such warranty periods any such product shall be proven to be defective, such product shall be repaired or replaced, at Vitalgo's option.

For warranty service, please contact the dealer from whom you purchased your Vitalgo Product.

LIMITATIONS AND EXCLUSIONS:

THE FOREGOING WARRANTY SHALL NOT APPLY TO SERIAL NUMBERED PRODUCTS IF THE SERIAL NUMBER HAS BEEN REMOVED OR DEFACED, PRODUCTS SUBJECTED TO NEGLIGENCE, ACCIDENT, IMPROPER OPERATION, MAINTENANCE OR STORAGE, PRODUCTS MODIFIED WITHOUT VITALGO'S EXPRESS WRITTEN CONSENT (INCLUDING, BUT NOT LIMITED TO MODIFICATION THROUGH THE USE OF UNAUTHORIZED PARTS OR ATTACHMENTS); PRODUCTS DAMAGED BY REASON OF REPAIRS MADE TO ANY COMPONENT WITHOUT THE SPECIFIC CONSENT OF VITALGO, OR TO A PRODUCT DAMAGED BY CIRCUMSTANCES BEYOND VITALGO'S CONTROL, AND SUCH EVALUATION WILL BE SOLELY DETERMINED BY VITALGO.

THE WARRANTY SHALL NOT APPLY TO NORMAL WEAR AND TEAR OR FAILURE TO ADHERE TO THE PRODUCT INSTRUCTIONS.

THE FOREGOING EXPRESS WARRANTY IS EXCLUSIVE AND IN LIEU OF ANY OTHER WARRANTIES WHATSOEVER, WHETHER EXPRESS OR IMPLIED, INCLUDING THE IMPLIED WARRANTIES OF MERCHANTABILITY AND FITNESS FOR A PARTICULAR PURPOSE, AND THE SOLE REMEDY FOR VIOLATIONS OF ANY WARRANTY WHATSOEVER, SHALL BE LIMITED TO REPAIR OR REPLACEMENT OF THE DEFECTIVE PRODUCT PURSUANT TO THE TERMS CONTAINED HEREIN. THE APPLICATION OF ANY IMPLIED WARRANTY WHATSOEVER SHALL NOT EXTEND BEYOND THE DURATION OF THE EXPRESS WARRANTY PROVIDED HEREIN.

VITALGO SHALL NOT BE LIABLE FOR ANY CONSEQUENTIAL OR INCIDENTAL DAMAGES WHATSOEVER.

ABOUT VITALGO SYSTEMS LTD.

VitalGo is comprised of both engineers and business executives who believe that functionality must come hand in hand with quality. All designs and final products are judged against the highest manufacturing standards, ensuring that every VitalGo product delivers the maximum levels of safety, comfort, functionality and reliability. At VitalGo, we are convinced that working to the highest standards is the only way; and every member of our team is proud to stand behind every one of our products.

OUR MISSION

At VitalGo Systems, we are committed to developing and implementing advanced products to address this vital and growing need for safe lifting modalities in hospitals, care facilities and homecare situations. Every aspect of our product design and development is guided by the belief that it is not enough to just bring the patient to a standing position; rather, it must be done in a way that ensures the safety of both the patient and the caregiver and with full respect for the patient's dignity. Based on a unique combination of advanced technologies, VitalGo's products fully address the threat of caregiver and patient injuries caused by transfers and they also can assist in various aspects of medical treatments and rehabilitation, such as physical therapy.

FLAGSHIP PRODUCT

VitalGo's flagship product, the innovative Total Lift Bed™, sets a new standard in user and caregiver safety and comfort. Designed for use in hospitals, nursing homes, and in rehabilitation facilities, the Total Lift Bed is the only bed that can raise the user from a lying position to a full standing position and all intermediate positions. Other products, currently in various stages of development, will provide innovative, safe and dignified solutions for bathing, Total Lift Chairs, and assistive products for other daily activities.

EUROPE OFFICE

7 Florins St.
Nicosia, Cyprus

NORTH-AMERICA OFFICE

3315 Commerce Pkwy.

Miramar, FL 33025
U.S.A.

Toll-free (877) 678-6781

sales@vitalgosys.com
www.vitalgosys.com